

HD

SY Series

HD2200Y/2200SY | HD2600Y/2600SY | HD3100YA/SYA | HD3100Y/SY

HYUNDAI WIA Y-Axis Turning Center

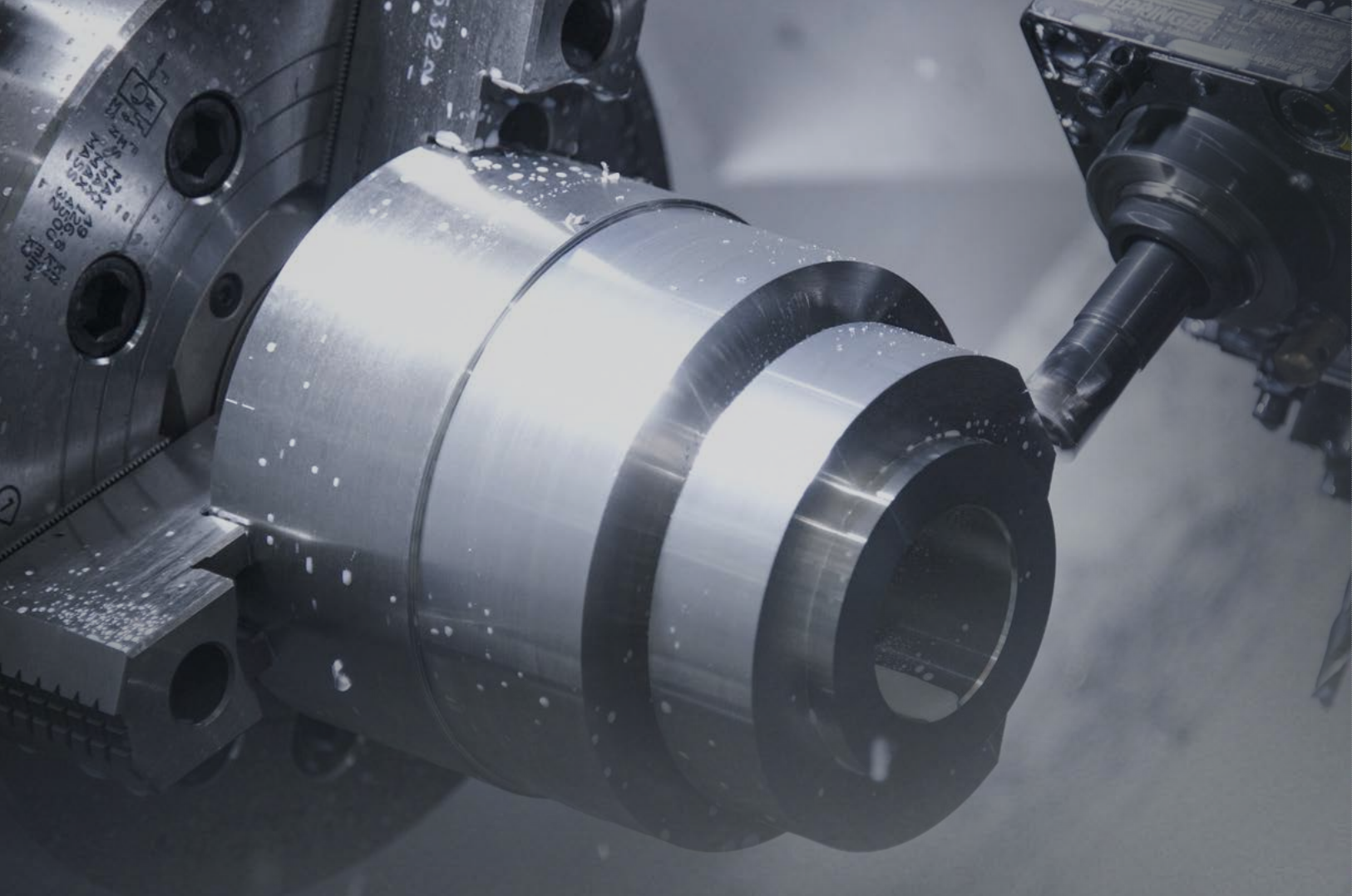

Technical Leader

The CNC Turning Center HD-SY Series, designed with HYUNDAI WIA's engineering expertise to maximize productivity by enhancing rigidity and accuracy of machining.

ITEM	Main Chuck			Sub Chuck		Bed (Z-Axis)			Mill Turret	
	8"	10"	12"	5"	6"	680mm (26.8")	830mm (32.7")	1350mm (53.1")	BMT55	BMT65
HD2200Y	●					●			●	
HD2200SY	●			●		●			●	
HD2600Y		●				●			●	
HD2600SY		●		●		●			●	
HD3100YA		●					●			●
HD3100SYA		●			●		●			●
HD3100Y			●				●			●
HD3100SY			●		●		●			●
HD3100LY			●					●		●
HD3100LYA		●						●		●

●: Standard ○: Option

HD

SY Series

Lathe with Y-axis & Box Guideways for Heavy Cutting

- Box guideways for heavy duty cutting
- 30° slanted one-piece bed structure for high rigidity
- Stabilized Unit Structure to minimize thermal displacement
- Integrated processing through synchronized control of Main/Sub spindle ('SY' Type)
- Multi-tasking operation with wedge type Y-axis BMT turret
- Excellent rapid traverse rate: 30m/min [1,181ipm] (Z-axis)
- Ergonomic design for convenient access to chuck and tool



Y-AXIS TURNING CENTER



APPLICATIONS & PARTS

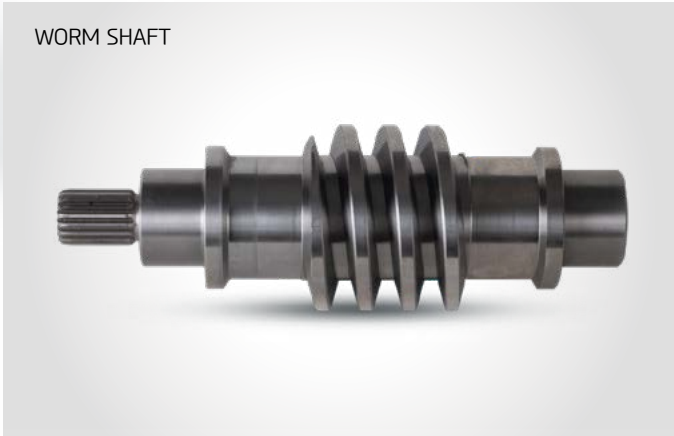

Reduced machining time by multi-tasking operation
 HD-SY Series with Y-axis makes it possible to work high-valued product with integrated processing using sub spindle and various rotary tools in short time.

WHEEL HUB



COOLING ADAPTER



HUB SHAFT



DRIVE GEAR



01 BASIC STRUCTURE

Which Can Cover All Machining Process with Only One Initial Setting

Mill Turret

- BMT55P
6,000 r/min, $\varnothing 16$ ($\varnothing 5/8$) {ER25}
- BMT65P
5,000 r/min, $\varnothing 25$ ($\varnothing 1$) {ER32}

Sub Spindle

- 5" / 6,000 r/min
- 6" / 4,500 r/min
- C-Axis Control : 0.001°

High Precision Spindle

- Integral body & heat dissipating RIB structure.
- HD2200Y/SY : 8" / 4,000 r/min
- HD2600Y/SY : 10" / 3,500 r/min
- HD3100YA/SYA : 10" / 3,500 r/min
- HD3100Y/SY : 12" / 2,800 r/min
- HD3100LY : 12" / 2,800 r/min
- HD3100LYA : 10" / 3,500 r/min
- C-Axis Control : 0.001°

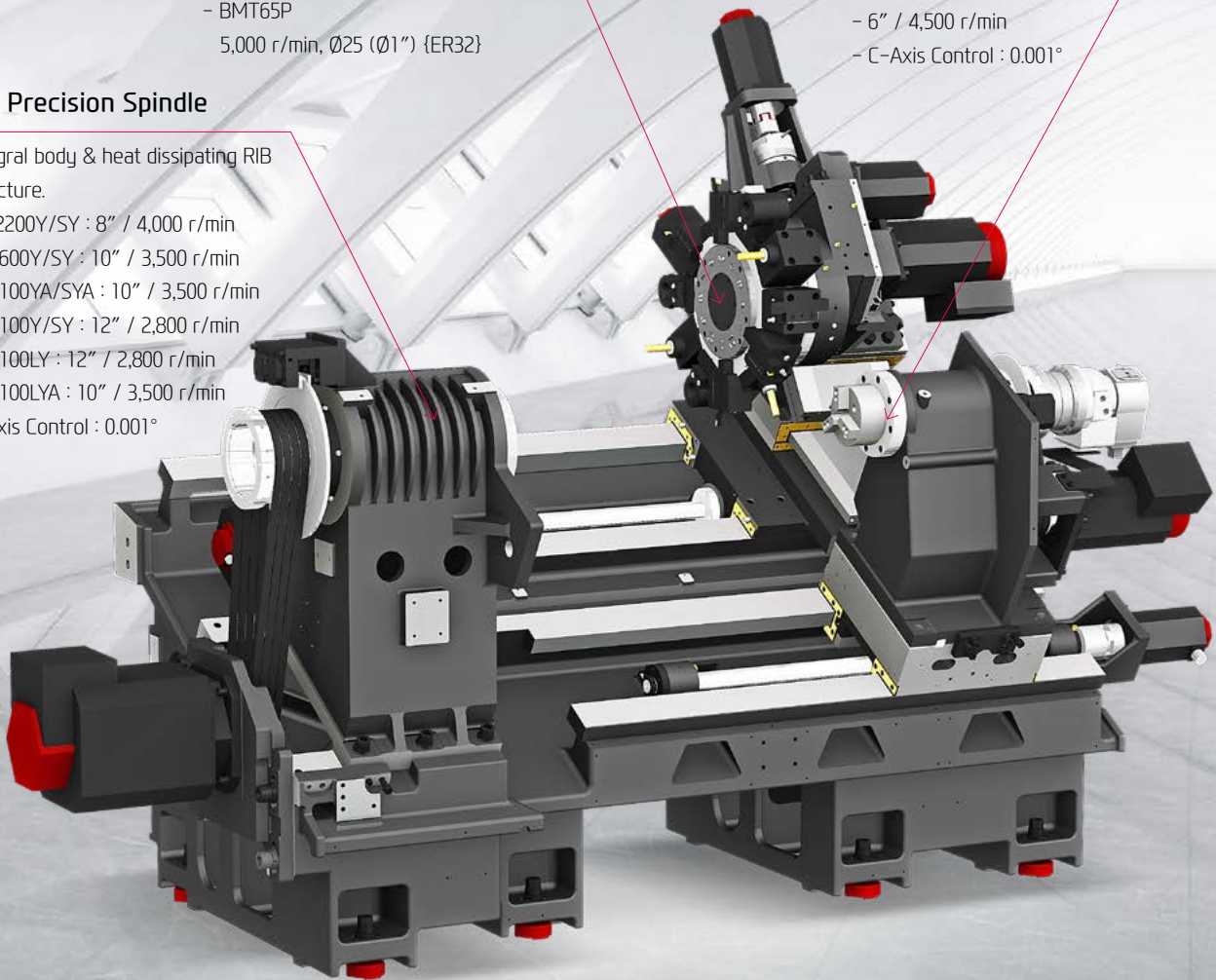

REDUCTION OF NON-CUTTING TIME BY FAST RAPID SPEED

ALL-IN-ONE TYPE OF BED

Optimal Structural Analysis

Structural analysis was applied to the design of the machine to increase the tool post body and reduce the machine's height so as to maintain the bed's dynamic rigidity even during heavy-duty cutting.

In addition, the HD-SY Series bed slope is pitched at 30 degrees to ensure more stable machining.



Integrated Coolant Tank

The structure is designed with the coolant tank installed at the bed front for improved convenience. Chips can be removed from the right side of the machine.

GUIDEWAY

Box Guideway

All axis of HD-SY Series are designed with Box Guideways for better travel ability. Box Guideways show great performance in offsetting vibrations caused by heavy duty cutting.

Sealed GIB Structure

X-axis of HD2200 is designed to minimize the damage of turcite from chips by applying the sealed GIB structure.

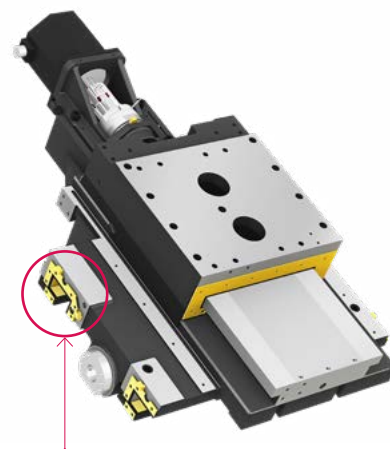

6-Face constraint design for improved travel capacity

Rapid Traverse Rate (X/Y/Z/ZB)

HD2200Y/SY, HD2600Y/SY

215/110/680/680 mm (8.5"/4.3"/26.8"/26.8")

HD3100YA/SYA, HD3100Y/SY

265/120/830/830 mm (10.4"/4.7"/32.7"/32.7")

HD3100LYA/LY

265/120/1,350/1,350 mm (10.4"/4.7"/53.1"/53.1")

02 Y-AXIS FUNCTION

The Y-Axis Function, Cutting for Complex Shaped Work-piece

HIGH PERFORMANCE Y-AXIS

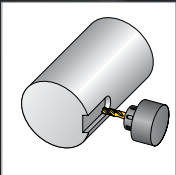

Keyway Milling

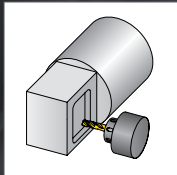

Multi-sided machining

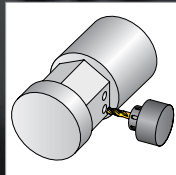

Eccentric hole machining

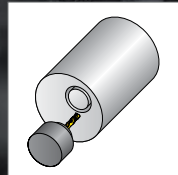

X+Y axis circular interpolation

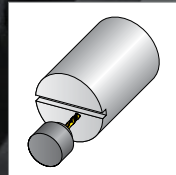

Fine Grooving

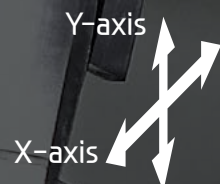

MACHINING PROCESS WITH ONLY ONE INITIAL SETTING

Y-AXIS

Wedge Type Y-Axis Structure

The HD-SY Series is designed with a wedge type Y-axis that is transferred by the simultaneous operation of the Ys-axis and the X-axis. In addition, excellent rigidity makes it possible to perform superb quality when machining a heavy-duty cutting.

Y-axis Rapid Traverse Rate

10 m/min (394 ipm)

Y-axis Travel

HD2200Y Series : 110 (±55) mm (4.3")

HD2600Y Series : 110 (±55) mm (4.3")

HD3100Y Series : 120 (±60) mm (4.7")

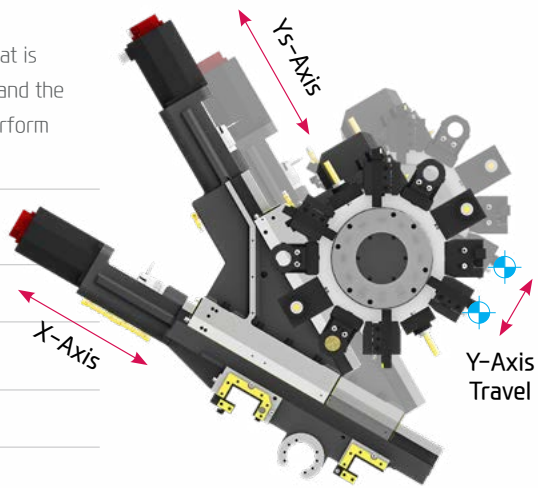

HD3100Y (12") Machining Capability

O.D Turning (Material : S45C)	
Machining Dia.	Ø172
Machining depth	7.5 mm
Spindle rpm	389 r/mim
Cutting speed	210 m/mim
Forwarding speed	0.55 mm/rev
Chip discharging amount	866 cc/min

End Mill (Material : S45C)	
Tool Dia.	Ø20 mm
Spindle rpm	675 r/mim
Forwarding speed	0.15 mm/rev
Cutting speed	86 m/mim
Machining depth	10 mm
Machining thickness	20 mm

I.D Turning (Material : S45C)	
Tool Dia.	Ø76.4
Machining depth	10 mm
Spindle rpm	750 r/mim
Cutting speed	180 m/mim
Forwarding speed	0.12 mm/rev

U-Drill (Material : S45C)	
Tool Dia.	Ø63
Machining depth	15 mm
Spindle rpm	1,011 r/mim
Cutting speed	200 m/mim
Forwarding speed	0.29 mm/rev

❖ The above result might be different by types of processing circumstances.

03 HIGH PRECISION SPINDLE

Long Lasting, High Accuracy & Excellent Performance CNC Turning Center



Spindle Specifications

[] : Option

ITEM	Spindle Speed	Motor (Max./Cont.)	Torque (Max./Cont.)	Type
HD2200Y/SY	4,000 (FANUC)	18.5/15 kW (25/20 HP)	206.2/125.4 N·m (152.1/92.5 lbf·ft)	BELT
	[4,000 (FANUC)]	[18.5/15 kW (25/20 HP)]	[353.5/215 N·m (260.7/158.6 lbf·ft)]	
	[4,000 (SIEMENS)]	[22.5/15 kW (30/20 HP)]	[215/143.3 N·m (158.6/105.7 lbf·ft)]	
HD2600Y/SY	3,500 (FANUC)	18.5/15 kW (25/20 HP)	400.7/243.7 N·m (295.5/179 lbf·ft)	
	[3,500 (SIEMENS)]	[32.3/17 kW (43.3/22.8 HP)]	[524.7/276.1 N·m (703.6/203.6 lbf·ft)]	
HD3100YA/SYA/LYA	3,500 (FANUC)	26/18.5 kW (35/25 HP)	734/522 N·m (541.4/385 lbf·ft)	
HD3100Y/SY/LY	2,800 (FANUC)	26/18.5 kW (35/25 HP)	1,051/672 N·m (775.2/495.6 lbf·ft)	

HEAVY DUTY CUTTING & HIGH ACCURACY

SPINDLE

Spindle for Heavy Cutting

The main spindle is designed with the same structure as that often found in larger sized machines. The combination of double cylindrical roller bearings and angular contact ball bearings leads to excellent heavy duty cutting performance. Also, machining performance is enhanced by applying ribstar belt to minimize noise and belt slipping problems.



C-Axis Control

C-axis of HD-SY Series can be controlled to 0.001° which makes it possible to process various shapes.

Sub Spindle ('SY' Type)

The Belt-type sub spindle is designed to minimize thermal displacement during the continuous machining, offering from the heavy-duty cutting to the high-speed machining.



HD2200SY/2600SY 5" (6,000 r/min)

HD3100SYA/3100SY 6" (4,500 r/min)

TAIL STOCK

The HD-Y series is fitted with tailstocks as a standard for excellent machining quality. In addition, the travel distance of quill can be as long as 120mm(4.7"), thus expanding the support area.

HD2200Y/2600Y MT#4 {Travel : 680 mm} (26.8")

HD3100YA/3100Y MT#5 {Travel : 830 mm} (32.7")

HD3100LYA/3100LY MT#5 {Travel : 1,350 mm} (53.1")



HD-SY SERIES

04 BMT TURRET

High speed, High Accuracy, Highly Reliable Servo Turret



VARIOUS DRIVEN PRECISION BMT TOOL HOLDERS

TURRET

Mill Turret

The BMT turret secures the tool with four bolts and key on the tool mounting surface of the turret, making it possible to powerfully fix the tool, ensuring high reliability in rigidity and precision.

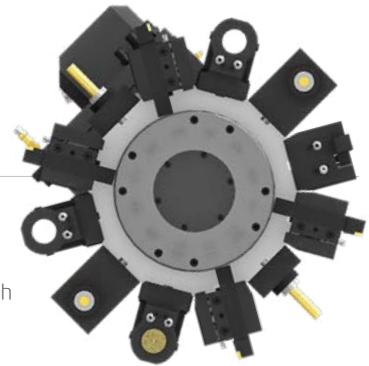

STRAIGHT MILLING HEAD



ANGULAR MILLING HEAD



Mill Tool Holder

Machining capability has increased with the addition of straight milling head tool holder, which can machine workpieces from the side, and angular milling head tool holder, which can perform I.D. operations.

BMT 55P (HD2200Y/SY | HD2600Y/SY)

- ⊙ Speed (rpm) : 6,000 r/min
- ⊙ Collet size : $\varnothing 16$ ($\varnothing 5/8''$) {ER25}
- ⊙ Indexing Time : 0.2 sec/step

BMT 65P (HD3100YA/SYA | HD3100Y/SY)

- ⊙ Speed (rpm) : 5,000 r/min
- ⊙ Collet size : $\varnothing 25$ ($\varnothing 1''$) {ER32}
- ⊙ Indexing Time : 0.2 sec/step

SPECIAL TOOL

OPTION

With the Y-axis, the HD-SY series can process high value-added products using a variety of rotating tools. In particular, there is a multi-holder for attaching a variety of tools to one holder, and an eccentric rotary tool for handling eccentric parts without additional axis travel, which can realize integration of process with one machine.

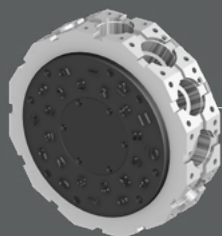

ANGLE HEAD

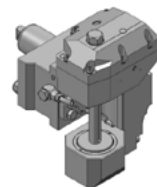

GEAR HOBBING HEAD

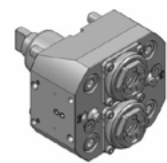

DOUBLE TYPE HEAD

❖ Consultation needed when ordering these options.

05 USER CONVENIENCE

Various Devices for User Friendly

BAR FEEDER SYSTEM

Bar Feeder

Bar feeder system enables automation which leads to efficiency improvement.



Parts Catcher

An optional parts catcher collects finished parts without the need to open the door, adding productivity, especially when a bar feeder is attached.



Auto Door

Using M-code, the doors can be automatically opened and closed which brings productivity and convenience for automation.



Parts Conveyor

The parts conveyor transfers the finished workpiece unloaded by the parts catcher for user convenience.



Auto Shutter

Using auto shutter, automation system with gantry loader is possible without opening the machine's door.

HIGH PRECISION SYSTEM



Automatic Q-Setter

Cutting tools are calibrated quickly and accurately with the addition of a q-setter. Each tool tip is touched off manually using a sensor that inputs the position automatically.



Linear Scale

Linear scales increase positioning accuracy and reduce distortion caused by thermal growth, thus ensuring a more accurate finished part



Work Probe

Workpiece coordinate values can be set automatically using the optional spindle probe.

Optional

COOLANT UNIT



Standard Coolant (Nozzle)



Chuck Coolant (Upper Chuck)



Chuck Air Blow (Upper Chuck)



Gun Coolant

CHIP DISPOSAL SOLUTION

Chip Conveyor

Timely and effective disposal of chips will enhance productivity as well as the working environment.

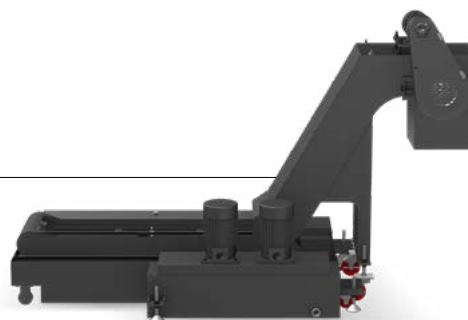

Hinge	Chip Type : Roughing Chip, Long Chip, Chip complex	Material : SS41, 45C, Cast Steel	Front-Right Direction
	Highly efficient when disposing a lot of chips. Capable of handling stringy chips..		
Scraper	Chip Type : Finely broken chip blown out	Material : cast Iron, Nonferrous	
	Convenient for shortly cut chips.		
❖ Drum Filter	Chip Type : Powder, Micro Chip	Material : AL	
	Advantageous in precision, as the chips do not flow in to the coolant nozzle.		

❖ When ordering a drum filter chip conveyor, prior consult with hyundai wia's sales person.

06 HYUNDAI WIA FANUC – SMART PLUS

The Compatible All-round Control



15" Touch-type Monitor as a standard

Fast Cycle Time Technology	Smart Machine Control	Fine Surface Technology
Smart Servo Control Technology	Conversational Program	SmartGuide-i
Machining-aid Function	i-HMI	
5120M (2MB)	Part Program Storage	
1000 EA	No. of Registerable Programs	

Servo Learning Oscillation Function for ChipBreaking **OPTION**

- Machining Method : he tool cuts the workpiece moving in a zigzag pattern. (Oscillating) → Air cut section occurs → Long chips break
- Advantage : Increase tool life, Enhance surface finishing, Improve chip disposal
- Machine : All turning centers with FANUC controller (Option)

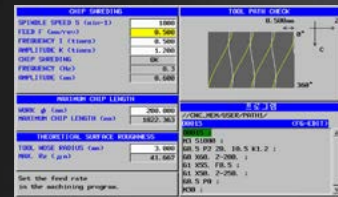
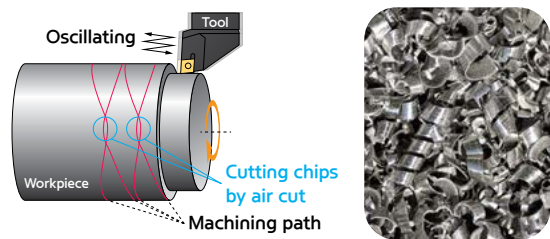

(Developed special screen page for servo learning oscillation function / Even when this function is applied, the cycle time remains same.)

MMS (Machine Monitoring System)

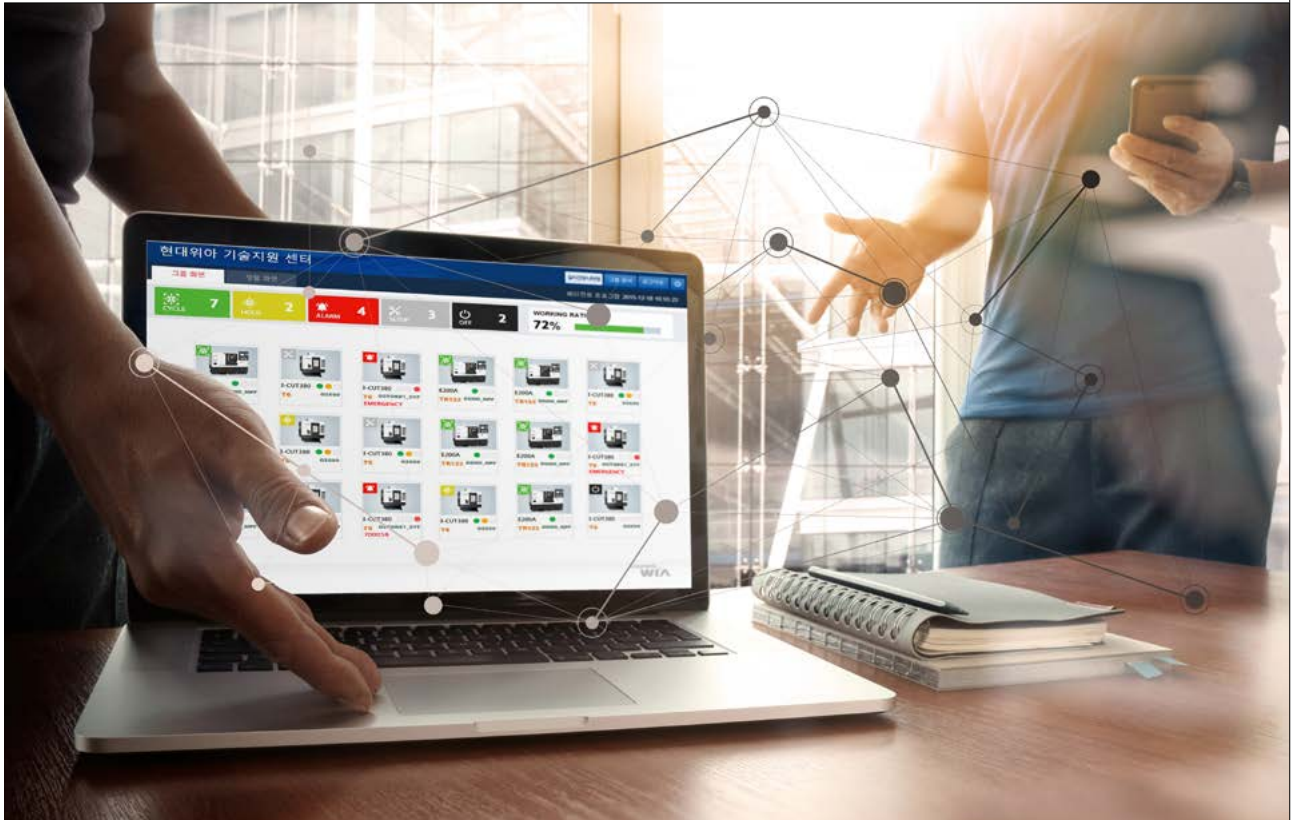

MMS Cloud

A cloud server-based equipment monitoring system for collecting and analyzing facility operation data.

Manufacturing big data solution with design, manufacturing, and intelligence technology of HYUNDAI-WIA (Big data collection/Analysis/Visualization)

SMART CNC (FANUC SMART PLUS)

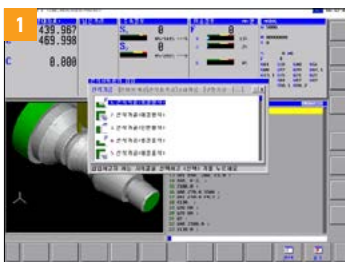

1. Dialogue Program (Smart Guide-i)

This software offers the maximum user convenience through dialogue manipulation from setup to processing. This includes writing processing programs and simulation checks.

2. LAUNCHER

This software offers shortcuts for quick access to specialized features and frequently used features.

SPECIFICATIONS

Standard & Optional

Spindle		HD2200Y/SY	HD2600Y/SY
Main Spindle	8"	●	-
Hollow Chuck 3 Jaw	10"	-	●
Main Spindle	8"	-	-
Solid Chuck 3 Jaw	10"	-	-
Sub SP. Hollow Chuck 3 Jaw	5"	-/●	-/●
Sub Sp. Solid Chuck 3 Jaw	5"	-	-
Standard Soft Jaw (1set)		●	●
Chuck Clamp Foot Switch		●	●
2 Steps Hyd. Pressure Device		○	○
Spindle Inside Stopper		☆	☆
Cs-Axis (0.001")		●	●
Chuck Open/Close Confirmation Device		●	●
2 Steps Chuck Foot Switch		○	○
Sub Spindle Foot Switch		-/●	-/●
Turret			
Tool Holder		●	●
Mill Turret	BMT	●	●
	12 Tool	●	●
	24 Tool	○	○
Straight Milling Head	Collet Type, 2ea	●	●
Angular Milling Head	Collet Type, 2ea	●	●
Straight Milling Head	Adapter Type	○	○
Angular Milling Head	Adapter Type	○	○
Boring Sleeve		●	●
Drill Socket		○	○
U-Drill Holder		●	●
U-Drill Holder Sleeve		●	●
Angle Head		☆	☆
Tail Stock & Steady Rest			
Quill Tail Stock	MT#4	●/-	●/-
	MT#5	-	-
Built-in Tail Stock		○/-	○/-
Programmable Tail Stock		○/-	○/-
Manual Hyd. Steady Rest		-	-
Standard Live Center		●/-	●/-
High Precision Live Center		☆/-	☆/-
2 Steps Tail Stock Pressure System		☆/-	☆/-
Quill Forward/Reverse Confirmation Device		○/-	○/-
Tail Stock Foot Switch		○/-	○/-
Coolant & Air Blow			
Standard Coolant (Nozzle)		●	●
Chuck Coolant (Upper Chuck)		○	○
Gun Coolant		○	○
Through Spindle Coolant (Only for Special Chuck)		☆	☆
Turnmill Through Coolant		-	-
Chuck Air Blow	Main SP.	○	○
	Sub SP.	-/○	-/○
Tail Stock Air Blow (Upper Tail Stock)		○/-	○/-
Turret Air Blow		☆	☆
Air Gun		○	○
Through Spindle Air Blow (Only for Special Chuck)		-	-
High Pressure Coolant	0.5Bar	●	●
	6Bar	○	○
	20Bar	○	○
	70Bar	○	○
Power Coolant System (For Automation)		☆	☆
Coolant Chiller (When selecting Sub Tank Type, Chip Conveyor)		-	-
Chip Disposal			
Coolant Tank	Right	●	●
	Rear	☆	☆
Chip Conveyor (Hinge/Scraper)	Front (Right)	○	○
	Rear (Rear)	☆	☆
Special Chip Conveyor (Drum Filter)		-	-
Chip Wagon	Standard (180 ℓ [47.5 gal])	○	○
	Swing (200 ℓ [52.8 gal])	○	○
	Large Size (330 ℓ [87.2 gal])	○	○
	Customized	☆	☆
Safety Device			
Front Door Interlock		●	●
Total Splash Guard		●	●
Chuck Hydraulic Pressure Maintenance Interlock		☆	☆

● : Standard ○ : Option ☆ : Prior Consultation - : Non Applicable

Electric Device		HD2200Y/SY	HD2600Y/SY
Call Light	1Color : ●	●	●
Call Light & Buzzer	3Color : ● ● ● B	○	○
Electric Cabinet Light		○	○
Remote MPG		○	○
Work Counter	Digital	○	○
Total Counter	Digital	○	○
Tool Counter	Digital	○	○
Multi Tool Counter	6EA	○	○
	9EA	○	○
Electric Circuit Breaker	FANUC	○	○
	SIEMENS	-	-
AVR (Auto Voltage Regulator)		☆	☆
Transformer	30kVA	○/-	○/-
	35kVA	-/○	-/○
Auto Power Off		○	○
Measurement			
Manual Q-Setter (Basic)		○	○
Manual Q-Setter (Renishaw)		○	○
Automatic Q-Setter (Renishaw)		○	○
Work Close Confirmation Device (Only for Special Chuck)	TACO	○	○
	SMC	○	○
Work Setter		○	○
Linear Scale	X/Y/Z axis	○	○
Coolant Level Sensor (Only for Chip Conveyor)		☆	☆
Environment			
Air Conditioner		○	○
Dehumidifier		○	○
Oil Mist Collector		☆	☆
Oil Skimmer (Only for Chip Conveyor)		○	○
MQL (Minimal Quantity Lubrication)		☆	☆
Fixture & Automation			
Auto Door		○	○
Auto Shutter (Only for Automatic System)		☆	☆
Sub Operation Pannel		☆	☆
Bar Feeder Interface		○	○
Bar Feeder		☆	☆
Work Pusher (Spring Type)		○	○
Work Ejector (Pneumatic Type)		☆	☆
Extra M-Code 4ea		○	○
Automation Interface		☆	☆
I/O Extension (IN & OUT)	16 Contact	○	○
	32 Contact	○	○
Parts Catcher	Main SP.	○	○
	Sub SP.	-/○	-/○
Turret Work Pusher (For Automation)		☆	☆
Parts Conveyor (Required Main Parts Catcher)		☆	☆
Semi Automation System		☆	☆
Hyd. Device			
Standard Hyd. Cylinder	Hollow	●	●
Standard Hyd. Unit	35bar(507.6psi) / 30 ℓ (7.9gal)	●	●
S/W			
Dialogue Program (HW-DPRO) : FANUC		○	○
DNC software (HW-eDNC)		○	○
Machine Monitoring System (HW-MMS Cloud)		☆	☆
Smart Guide-i : FANUC		●	●
Smart S/W		☆	☆
ETC			
Tool Box		●	●
Customized Color	Need Munsell No.	☆	☆
CAD & CAM		☆	☆

❖ Thermal Displacement Compensation device is recommended, when more than 6 bar of high pressure coolant is applied, for the high quality machining.

Specifications are subject to change without notice for improvement. / Please refer to the S/W catalog (IRIS) for details by S/W product.

SPECIFICATIONS

Standard & Optional

● : Standard ○ : Option ☆ : Prior Consultation - : Non Applicable

Spindle		HD3100YA/SYA	HD3100Y/SY
Main Spindle	10"	●	-
Hollow Chuck 3 Jaw	12"	-	●
Main Spindle	10"	-	-
Solid Chuck 3 Jaw	12"	-	-
Sub SP. Hollow Chuck 3 Jaw	6"	-/●	-/●
Sub Sp. Solid Chuck 3 Jaw	6"	-	-
Standard Soft Jaw (1set)		●	●
Chuck Clamp Foot Switch		●	●
2 Steps Hyd. Pressure Device		○	○
Spindle Inside Stopper		☆	☆
Cs-Axis (0.001")		●	●
Chuck Open/Close Confirmation Device		●	●
2 Steps Chuck Foot Switch		○	○
Sub Spindle Foot Switch		-/●	-/●
Turret			
Tool Holder		●	●
Mill Turret	BMT	●	●
	12 Tool	●	●
	24 Tool	-	-
Straight Milling Head	Collet Type, 2ea	●	●
Angular Milling Head	Collet Type, 2ea	●	●
Straight Milling Head	Adapter Type	○	○
Angular Milling Head	Adapter Type	○	○
Boring Sleeve		●	●
Drill Socket		○	○
U-Drill Holder		●	●
U-Drill Holder Sleeve		●	●
Angle Head		☆	☆
Tail Stock & Steady Rest			
Quill Tail Stock	MT#4	-	-
	MT#5	●/-	●/-
Built-in Tail Stock		○/-	○/-
Programmable Tail Stock		○/-	○/-
Manual Hyd. Steady Rest		-	-
Standard Live Center		●/-	●/-
High Precision Live Center		☆/-	☆/-
2 Steps Tail Stock Pressure System		☆/-	☆/-
Quill Forward/Reverse Confirmation Device		○/-	○/-
Tail Stock Foot Switch		○/-	○/-
Coolant & Air Blow			
Standard Coolant (Nozzle)		●	●
Chuck Coolant (Upper Chuck)		○	○
Gun Coolant		○	○
Through Spindle Coolant (Only for Special Chuck)		☆	☆
Turnmill Through Coolant		-	-
Chuck Air Blow	Main SP.	○	○
	Sub SP.	-/○	-/○
Tail Stock Air Blow (Upper Tail Stock)		○/-	○/-
Turret Air Blow		☆	☆
Air Gun		○	○
Through Spindle Air Blow (Only for Special Chuck)		-	-
High Pressure Coolant	0.5Bar	●	●
	6Bar	○	○
	20Bar	○	○
	70Bar	○	○
Power Coolant System (For Automation)		☆	☆
Coolant Chiller (When selecting Sub Tank Type, Chip Conveyor)		-	-
Chip Disposal			
Coolant Tank	Right	●	●
	Rear	☆	☆
Chip Conveyor (Hinge/Scraper)	Front (Right)	○	○
	Rear (Rear)	☆	☆
Special Chip Conveyor (Drum Filter)		-	-
Chip Wagon	Standard (180 ℓ [47.5 gal])	○	○
	Swing (200 ℓ [52.8 gal])	○	○
	Large Size (330 ℓ [87.2 gal])	○	○
	Customized	☆	☆
Safety Device			
Front Door Interlock		●	●
Total Splash Guard		●	●
Chuck Hydraulic Pressure Maintenance Interlock		☆	☆

Electric Device		HD3100YA/SYA	HD3100Y/SY
Call Light	1Color : ●	●	●
Call Light & Buzzer	3Color : ●●●	○	○
Electric Cabinet Light		○	○
Remote MPG		○	○
Work Counter	Digital	○	○
Total Counter	Digital	○	○
Tool Counter	Digital	○	○
Multi Tool Counter	6EA	○	○
	9EA	○	○
Electric Circuit Breaker		○	○
AVR (Auto Voltage Regulator)		☆	☆
Transformer	30kVA	○/-	○/-
	39kVA	-/○	-/○
Auto Power Off		○	○
Measurement			
Manual Q-Setter (Basic)		○	○
Manual Q-Setter (Renishaw)		○	○
Automatic Q-Setter (Renishaw)		○	○
Work Close Confirmation Device (Only for Special Chuck)	TACO	☆	☆
	SMC	☆	☆
Work Setter		☆	☆
Linear Scale	X/Y/Z axis	☆	☆
Coolant Level Sensor (Only for Chip Conveyor)		☆	☆
Environment			
Air Conditioner		○	○
Dehumidifier		○	○
Oil Mist Collector		☆	☆
Oil Skimmer (Only for Chip Conveyor)		○	○
MQL (Minimal Quantity Lubrication)		☆	☆
Fixture & Automation			
Auto Door		○	○
Auto Shutter (Only for Automatic System)		☆	☆
Sub Operation Panel		☆	☆
Bar Feeder Interface		○	○
Bar Feeder		☆	☆
Work Pusher (Spring Type)		○	○
Work Ejector (Pneumatic Type)		☆	☆
Extra M-Code 4ea		○	○
Automation Interface		☆	☆
I/O Extension (IN & OUT)	16 Contact	○	○
	32 Contact	○	○
Parts Catcher	Main SP.	○	○
	Sub SP.	-/○	-/○
Turret Work Pusher (For Automation)		☆	☆
Parts Conveyor (Required Main Parts Catcher)		☆	☆
Semi Automation System		☆	☆
Hyd. Device			
Standard Hyd. Cylinder	Hollow	●	●
Standard Hyd. Unit	35bar(507.6psi) / 30 ℓ (7.9gal)	●	●
S/W			
Dialogue Program (HW-DPRO) : FANUC		○	○
DNC software (HW-eDNC)		○	○
Machine Monitoring System (HW-MMS Cloud)		☆	☆
Smart Guide-i : FANUC		●	●
Smart S/W		☆	☆
ETC			
Tool Box		●	●
Customized Color	Need Munsel No.	☆	☆
CAD & CAM		☆	☆

❖ Thermal Displacement Compensation device is recommended, when more than 6 bar of high pressure coolant is applied, for the high quality machining.

Specifications are subject to change without notice for improvement. / Please refer to the S/W catalog (IRIS) for details by S/W product.

SPECIFICATIONS

Standard & Optional

● 표준사양 ○ 선택사양 ☆ 기술협의 - 적용불가

Spindle		HD2200Y/SY	HD2600Y/SY
Main Spindle	8"	●	-
Hollow Chuck 3 Jaw	10"	-	●
Main Spindle	8"	-	-
Solid Chuck 3 Jaw	10"	-	-
Sub SP. Hollow Chuck 3 Jaw	5"	-	-
Sub Sp. Solid Chuck 3 Jaw	5"	-	-
Standard Soft Jaw (1set)		●	●
Chuck Clamp Foot Switch		●	●
2 Steps Hyd. Pressure Device		○	○
Spindle Inside Stopper		☆	☆
Cs-Axis (0.001")		●	●
Chuck Open/Close Confirmation Device		●	●
2 Steps Chuck Foot Switch		○	○
Sub Spindle Foot Switch		-	-
Turret			
Tool Holder		●	●
Mill Turret	BMT	●	●
	12 Tool	●	●
	24 Tool	-	-
Straight Milling Head	Collet Type, 2ea	●	●
Angular Milling Head	Collet Type, 2ea	●	●
Straight Milling Head	Adapter Type	○	○
Angular Milling Head	Adapter Type	○	○
Boring Sleeve		●	●
Drill Socket		○	○
U-Drill Holder		●	●
U-Drill Holder Sleeve		●	●
Angle Head		☆	☆
Tail Stock & Steady Rest			
Quill Tail Stock	MT#4	-	-
	MT#5	●	●
Built-in Tail Stock		○	○
Programmable Tail Stock		○	○
Manual Hyd. Steady Rest		-	-
Standard Live Center		●	●
High Precision Live Center		☆	☆
2 Steps Tail Stock Pressure System		☆	☆
Quill Forward/Reverse Confirmation Device		○	○
Tail Stock Foot Switch		○	○
Coolant & Air Blow			
Standard Coolant (Nozzle)		●	●
Chuck Coolant (Upper Chuck)		○	○
Gun Coolant		○	○
Through Spindle Coolant (Only for Special Chuck)		☆	☆
Turnmill Through Coolant		-	-
Chuck Air Blow	Main SP.	○	○
	Sub SP.	-	-
Tail Stock Air Blow (Upper Tail Stock)		○	○
Turret Air Blow		☆	☆
Air Gun		○	○
Through Spindle Air Blow (Only for Special Chuck)		-	-
High Pressure Coolant	0.5Bar	●	●
	6Bar	○	○
	20Bar	○	○
	70Bar	○	○
Power Coolant System (For Automation)		☆	☆
Coolant Chiller (When selecting Sub Tank Type, Chip Conveyor)		-	-
Chip Disposal			
Coolant Tank	Right	●	●
	Rear	☆	☆
Chip Conveyor (Hinge/Scraper)	Front (Right)	○	○
	Rear (Rear)	☆	☆
Special Chip Conveyor (Drum Filter)		-	-
Chip Wagon	Standard (180 ℓ [47.5 gal])	○	○
	Swing (200 ℓ [52.8 gal])	○	○
	Large Size (330 ℓ [87.2 gal])	○	○
	Customized	☆	☆
Safety Device			
Front Door Interlock		●	●
Total Splash Guard		●	●
Chuck Hydraulic Pressure Maintenance Interlock		☆	☆

Electric Device		HD2200Y/SY	HD2600Y/SY
Call Light	1Color : ●	●	●
Call Light & Buzzer	3Color : ● ● ● B	○	○
Electric Cabinet Light		○	○
Remote MPG		○	○
Work Counter	Digital	○	○
Total Counter	Digital	○	○
Tool Counter	Digital	○	○
Multi Tool Counter	6EA	○	○
	9EA	○	○
Electric Circuit Breaker		○	○
AVR (Auto Voltage Regulator)		☆	☆
Transformer	30kVA	○	○
	35kVA	-	-
Auto Power Off		○	○
Measurement			
Manual Q-Setter (Basic)		○	○
Manual Q-Setter (Renishaw)		○	○
Automatic Q-Setter (Renishaw)		○	○
Work Close Confirmation Device (Only for Special Chuck)	TACO	☆	☆
	SMC	☆	☆
Work Setter		☆	☆
Linear Scale	X/Y/Z axis	☆	☆
Coolant Level Sensor (Only for Chip Conveyor)		☆	☆
Environment			
Air Conditioner		○	○
Dehumidifier		○	○
Oil Mist Collector		☆	☆
Oil Skimmer (Only for Chip Conveyor)		○	○
ML (Minimal Quantity Lubrication)		☆	☆
Fixture & Automation			
Auto Door		○	○
Auto Shutter (Only for Automatic System)		☆	☆
Sub Operation Pannel		☆	☆
Bar Feeder Interface		○	○
Bar Feeder		☆	☆
Work Pusher (Spring Type)		○	○
Work Ejector (Pneumatic Type)		☆	☆
Extra M-Code 4ea		○	○
Automation Interface		☆	☆
I/O Extension (IN & OUT)	16 Contact	○	○
	32 Contact	○	○
Parts Catcher	Main SP.	○	○
	Sub SP.	-	-
Turret Work Pusher (For Automation)		☆	☆
Parts Conveyor (Required Main Parts Catcher)		☆	☆
Semi Automation System		☆	☆
Hyd. Device			
Standard Hyd. Cylinder	Hollow	●	●
Standard Hyd. Unit	35bar(507.6psi) / 30 ℓ (7.9gal)	●	●
S/W			
Dialogue Program (HW-DPRO) : FANUC		○	○
DNC software (HW-eDNC)		○	○
Machine Monitoring System (HW-MMS Cloud)		☆	☆
Smart Guide-i : FANUC		●	●
Smart S/W		☆	☆
기타			
Tool Box		●	●
Customized Color	Need Munsell No.	☆	☆
CAD & CAM		☆	☆

SPECIFICATIONS

Spindle Output/Torque Diagram

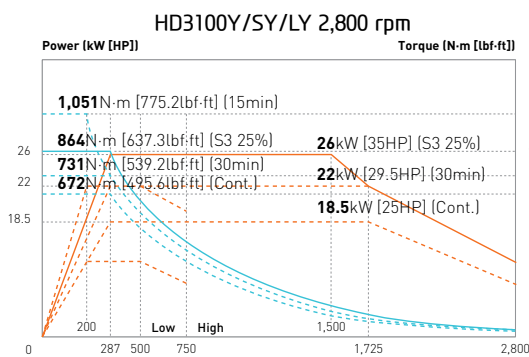
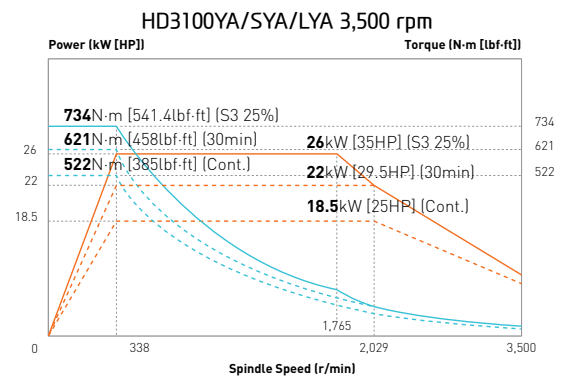
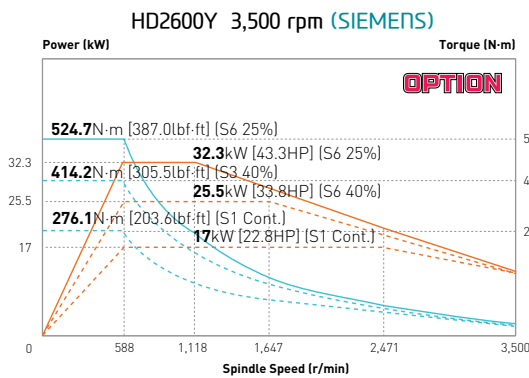
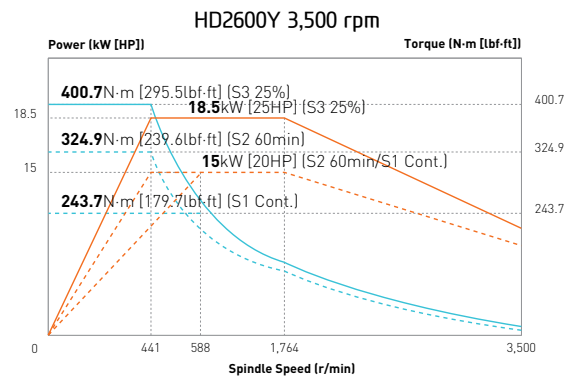
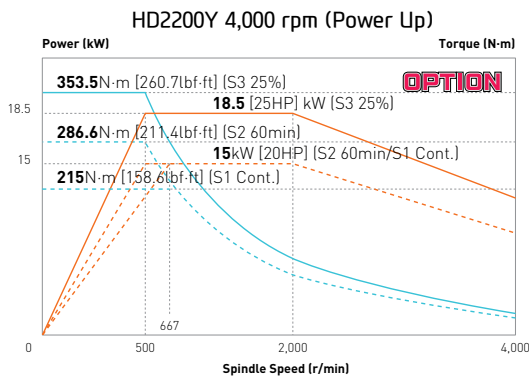
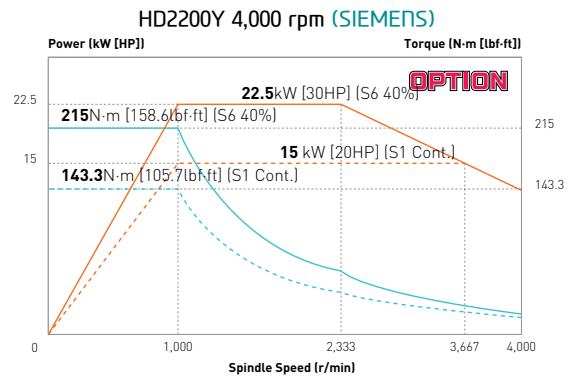
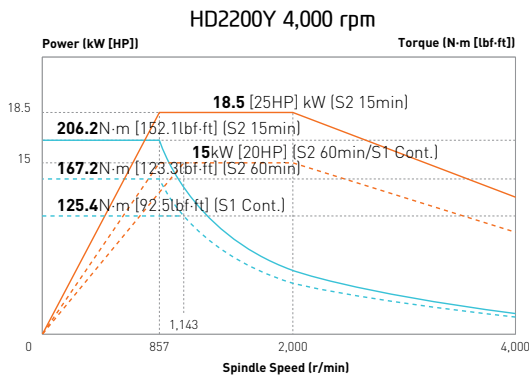

SPECIFICATIONS

Spindle Output/Torque Diagram

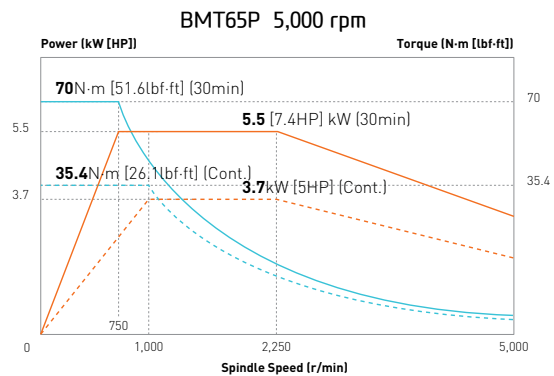
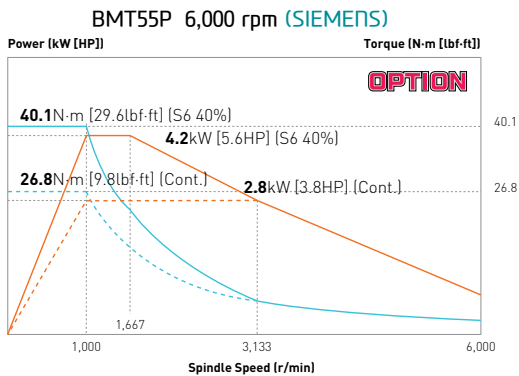
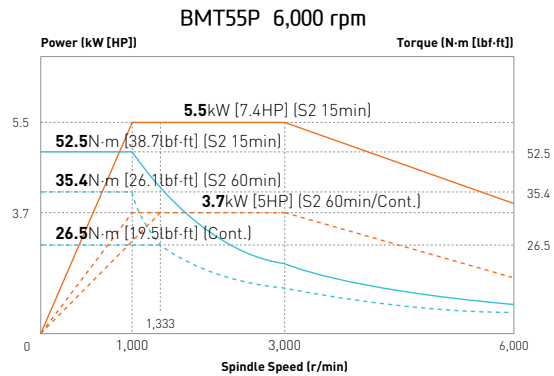
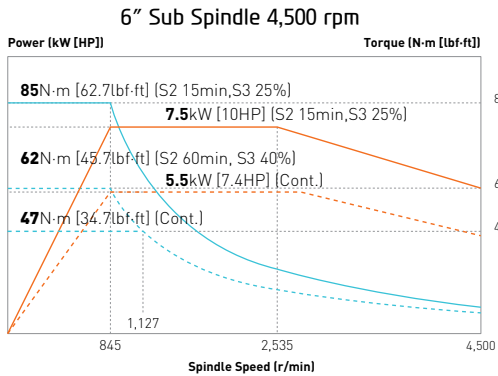
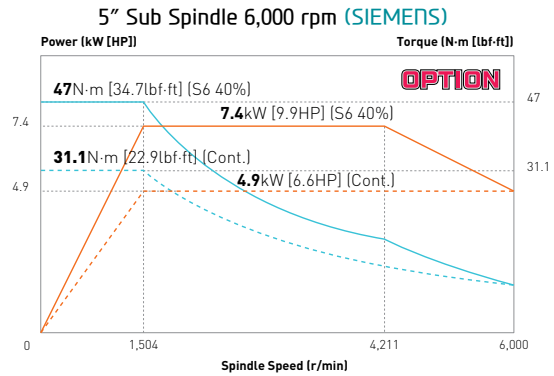
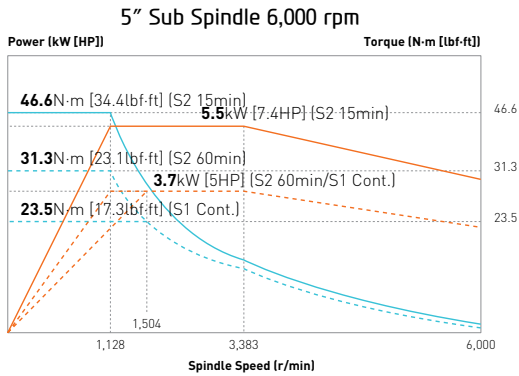

SPECIFICATIONS

External Dimensions

unit : mm

HD3100YA/SYA
HD3100Y/SY

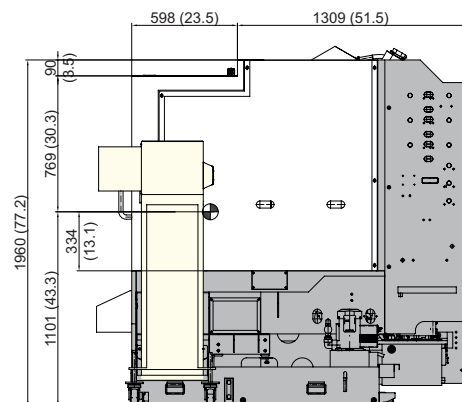
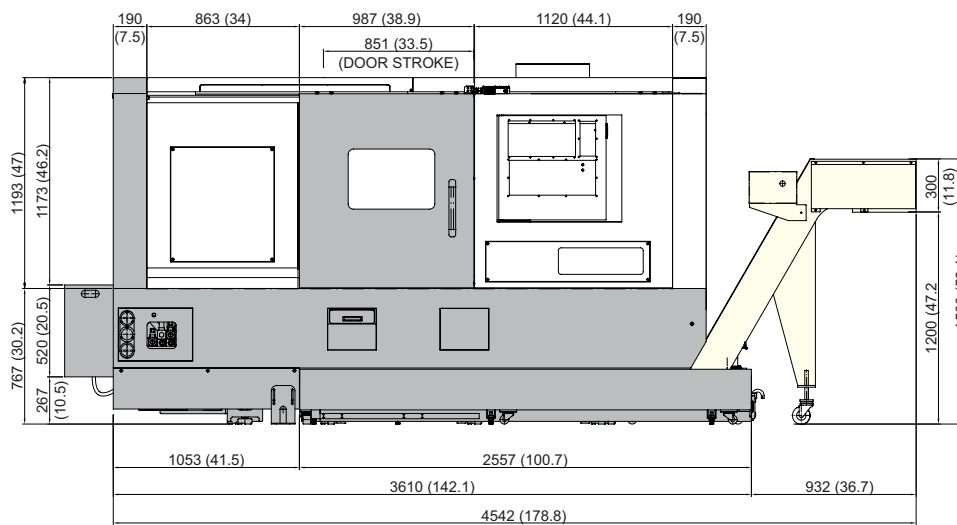
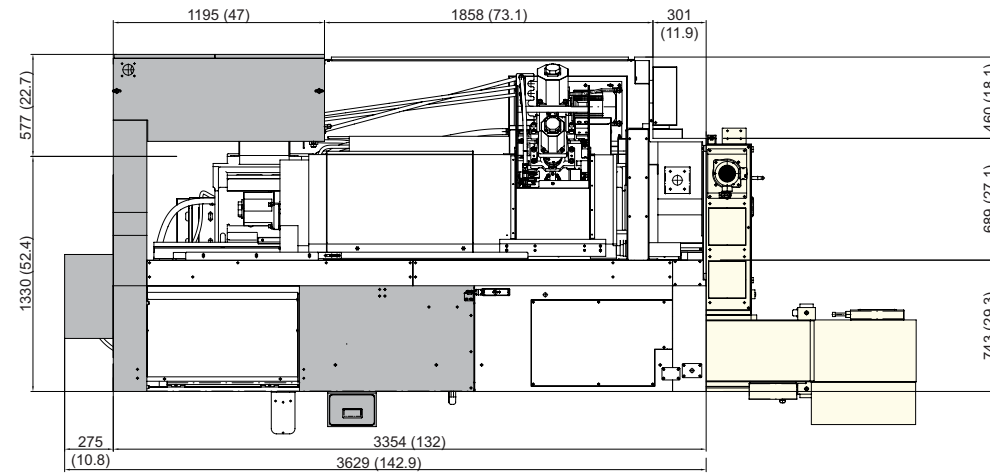

SPECIFICATIONS

External Dimensions

unit : mm

HD3100LY/LYA

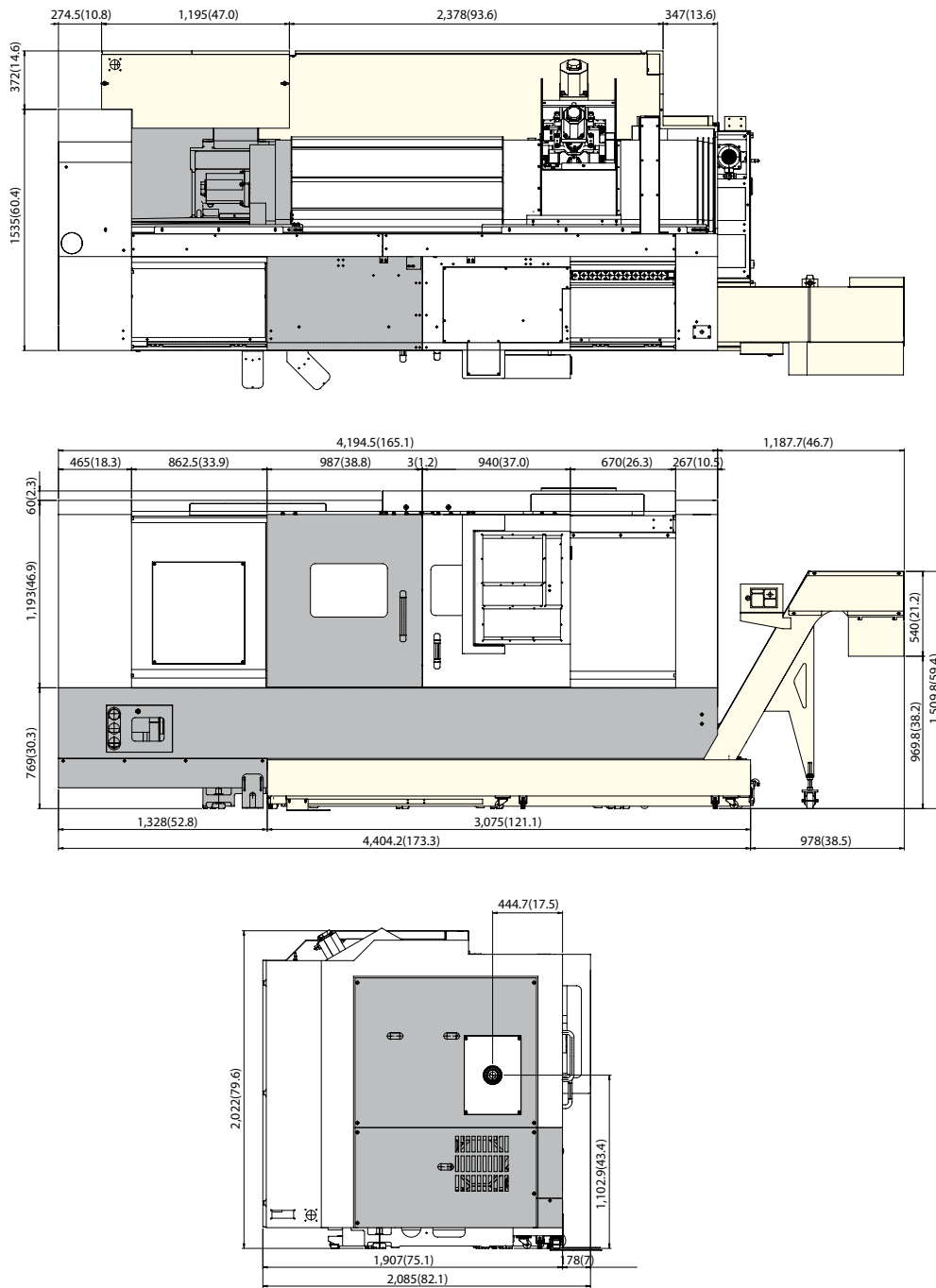

SPECIFICATIONS

Interference

unit : mm(in)

HD2200Y
HD2600Y

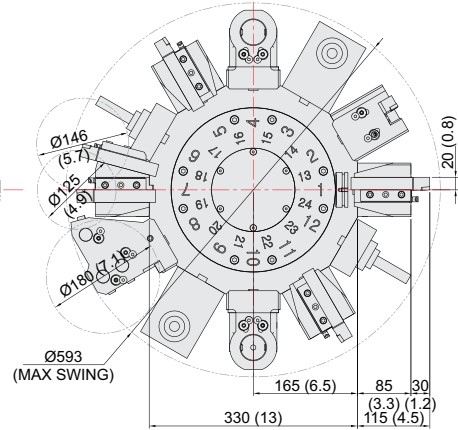
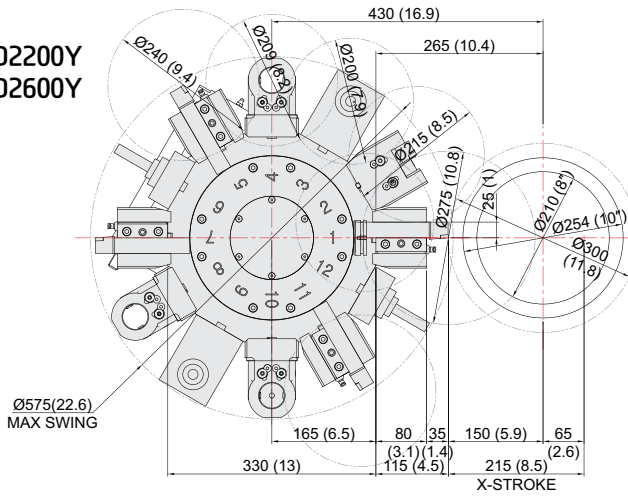

24 Station (Opt.)

HD2200SY
HD2600SY

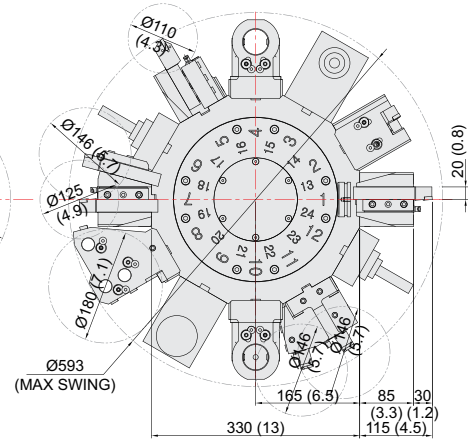
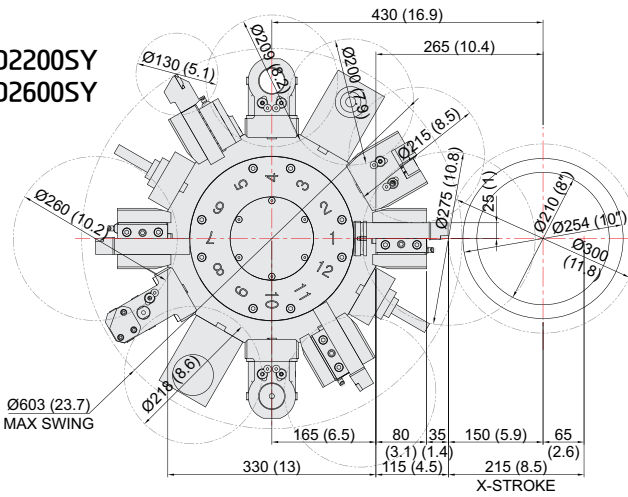

24 Station (Opt.)

Y-axis Travel Range

unit : mm(in)

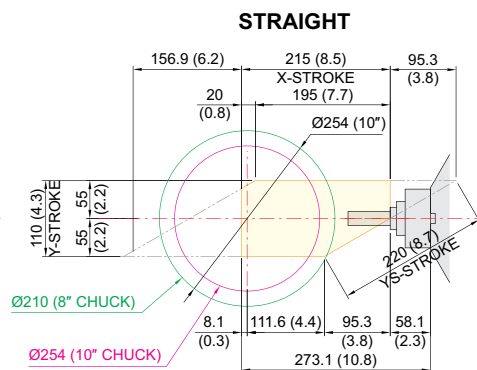
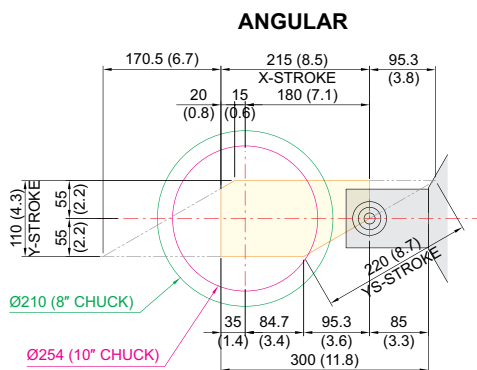

SPECIFICATIONS

Interference

unit : mm(in)

HD3100SYA
HD3100SY

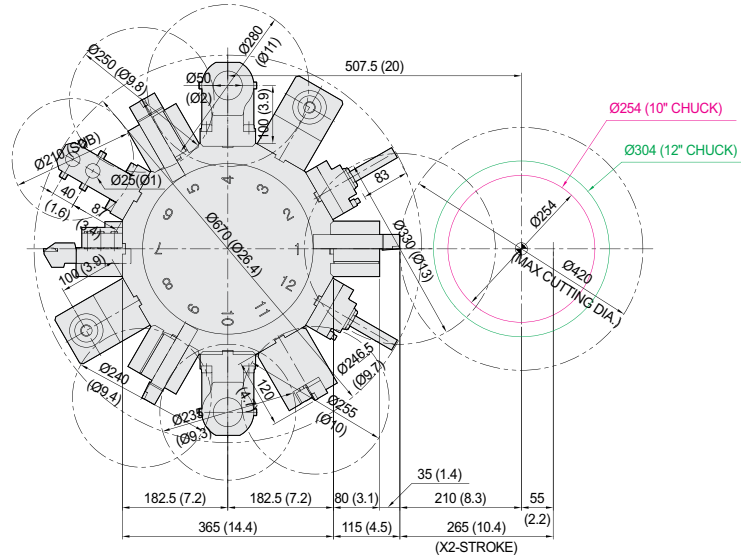

HD3100YA
HD3100Y
HD3100LYA
HD3100LY

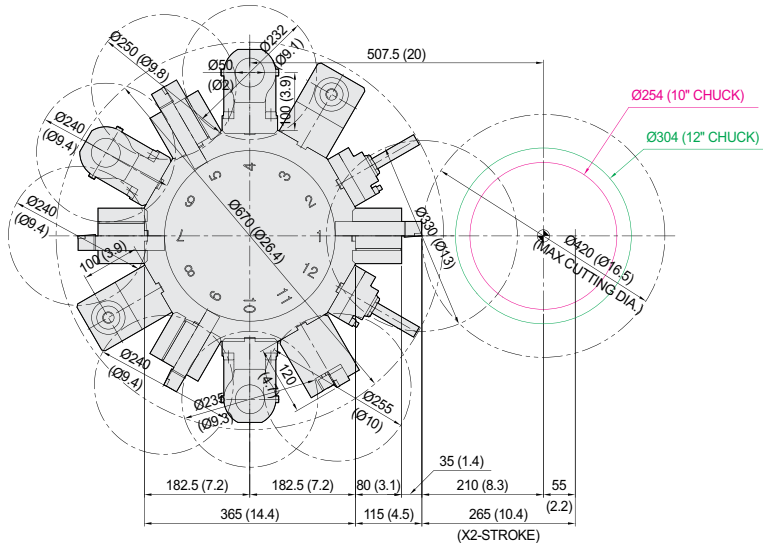

Y-axis Travel Range

unit : mm(in)

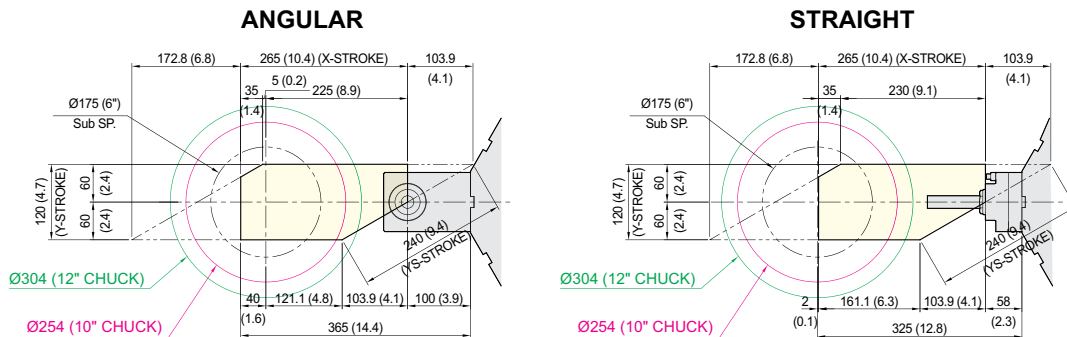

SPECIFICATIONS

Tooling System

unit : mm(in)

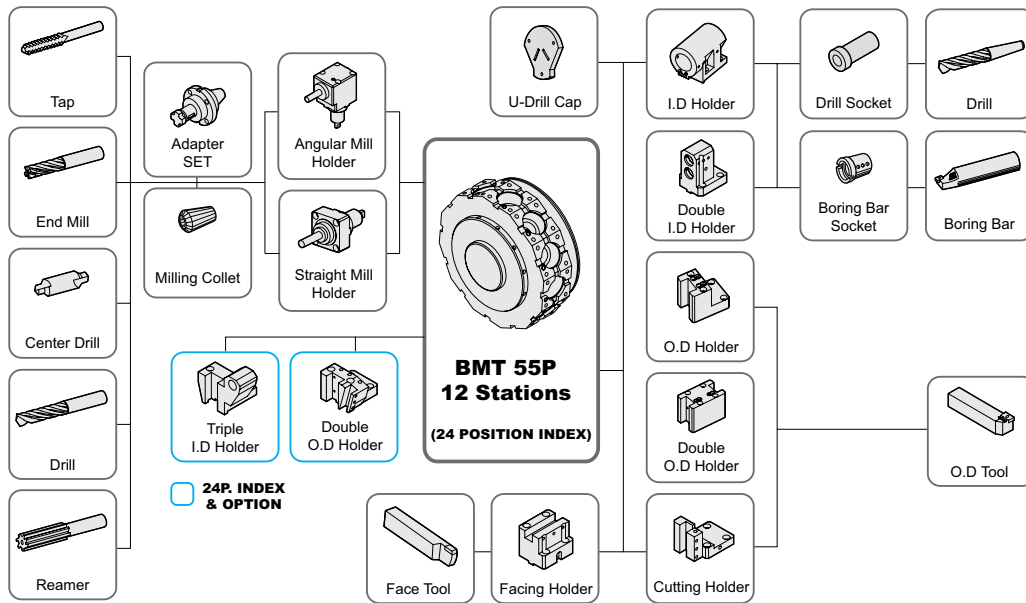

HD2200Y | HD2600Y Tooling Parts Detail

ITEM			Y Type (12P)		Y Type (24P : Opt.)		
			mm Unit	inch Unit	mm Unit	inch Unit	
Turning Holder	O.D Holder	Right/Left	4	4	3	3	
		Double	-	-	-	-	
		Double (24P, Main)	-	-	1	1	
		Double (24P, Sub)	-	-	-	-	
	Facing Holder		1	1	1	1	
	Cutting Holder		-	-	-		
Boring Holder	I.D Holder	Single	3	3	2	2	
		Double	-	-	-	-	
		Triple	-	-	1	1	
	U-Drill Holder	Cap	1	1	1	1	
Driven Holder	Straight Mill Holder	Standard	2	2	2	2	
	Angular Mill Holder	Standard	2	2	2	2	
Socket	Boring	Ø10 (Ø3/8")	1	1	1	1	
		Ø12 (Ø1/2")	1	1	1	1	
		Ø16 (Ø5/8")	1	1	1	1	
		Ø20 (Ø3/4")	1	1	1	1	
		Ø25 (Ø1")	1	1	1	1	
		Ø32 (Ø1 1/4")	1	1	1	1	
	Sub Boring	Ø8 (5/16")	-	-	-	-	
		Ø12 (1/2")	-	-	-	-	
		Ø16 (5/8")	-	-	-	-	
	Drill	MT 2	-	-	-	-	
		MT 3	-	-	-	-	
		MT 4	-	-	-	-	
		ER Collet		1 Set	1 Set	1 Set	1 Set
		Adapter Set		Opt.	Opt.	Opt.	Opt.

SPECIFICATIONS

Tooling System

unit : mm(in)

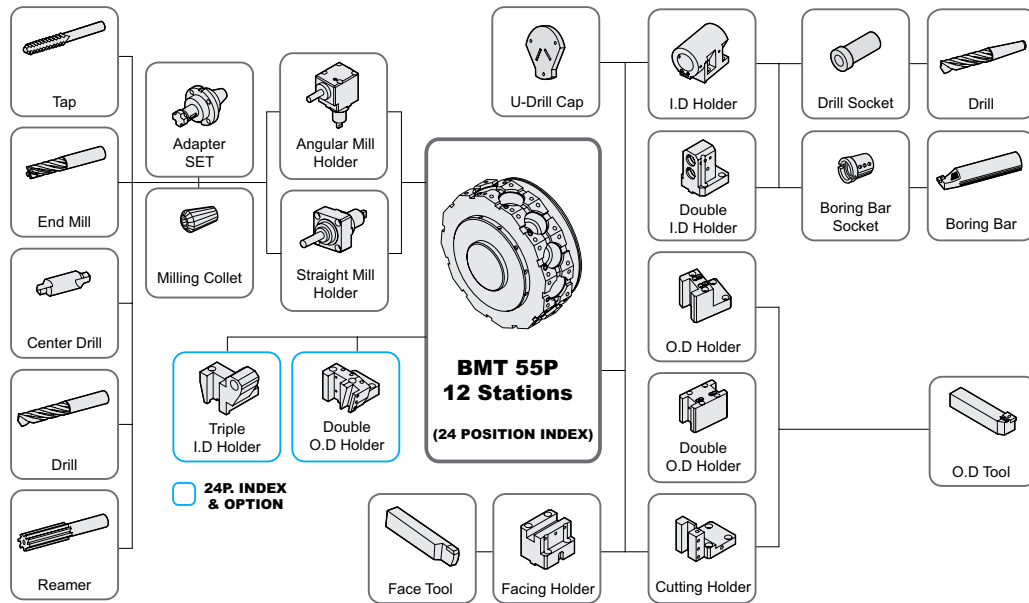

HD2200SY | HD2600SY Tooling Parts Detail

ITEM			SY Type (12P)		SY Type (24P : Opt.)	
			mm Unit	inch Unit	mm Unit	inch Unit
Turning Holder	O.D Holder	Right/Left	2	2	2	2
		Double	1	1	-	-
		Double (24P, Main)	-	-	1	1
		Double (24P, Sub)	-	-	1	1
	Facing Holder		1	1	1	1
Cutting Holder		1	1	1	1	
Boring Holder	I.D Holder	Single	2	2	2	2
		Double	1	1	-	-
		Triple	-	-	1	1
	U-Drill Holder	Cap	1	1	1	1
Driven Holder	Straight Mill Holder	Standard	2	2	2	2
	Angular Mill Holder	Standard	2	2	2	2
Socket	Boring	Ø10 (Ø3/8")	1	1	1	1
		Ø12 (Ø1/2")	1	1	1	1
		Ø16 (Ø5/8")	1	1	1	1
		Ø20 (Ø3/4")	1	1	1	1
		Ø25 (Ø1")	1	1	1	1
		Ø32 (Ø1 1/4")	1	1	1	1
	Sub Boring	Ø8 (5/16")	1	1	1	1
		Ø12 (1/2")	1	1	1	1
		Ø16 (5/8")	1	1	1	1
	Drill	MT 2	-	-	-	-
		MT 3	-	-	-	-
		MT 4	-	-	-	-
	ER Collet		1 Set	1 Set	1 Set	1 Set
	Adapter Set		Opt.	Opt.	Opt.	Opt.

Specifications are subject to change without notice for improvement.

SPECIFICATIONS

Tooling System

unit : mm(in)

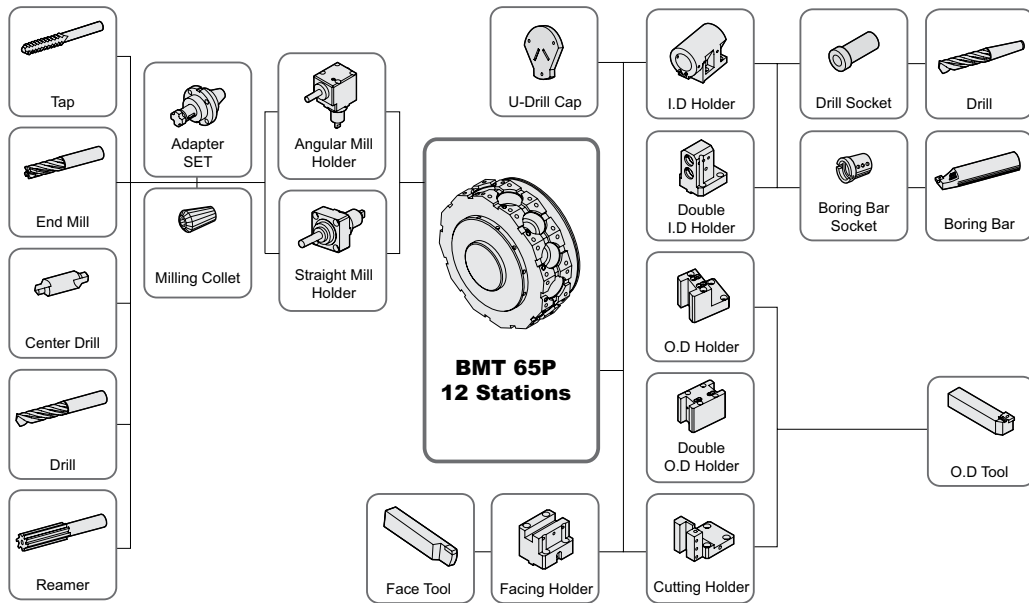

HD3100YA/SYA | HD3100Y/SY Tooling Parts Detail

ITEM			Y Type (12P)		SY Type (12P)	
			mm Unit	inch Unit	mm Unit	inch Unit
Turning Holder	O.D Holder	Right/Left	4	4	2	2
		Double	-	-	1	1
		Double (24P, Main)	-	-	-	-
		Double (24P, Sub)	-	-	-	-
	Facing Holder		1	1	1	1
	Cutting Holder		-	-	1	1
Boring Holder	I.D Holder	Single	3	3	2	2
		Double	-	-	1	1
		Triple	-	-	-	-
	U-Drill Holder	Cap	1	1	1	1
Driven Holder	Straight Mill Holder	Standard	2	2	2	2
	Angular Mill Holder	Standard	2	2	2	2
Socket	Boring	Ø12 (Ø3/8")	1	1	1	1
		Ø16 (Ø5/8")	1	1	1	1
		Ø20 (Ø3/4")	1	1	1	1
		Ø25 (Ø1")	1	1	1	1
		Ø32 (Ø1 1/4")	1	1	1	1
		Ø40 (Ø1 1/2")	1	1	1	1
	Sub Boring	Ø12 (Ø3/8")	-	-	1	1
		Ø16 (Ø5/8")	-	-	1	1
		Ø20 (Ø3/4")	-	-	1	1
	Drill	MT 2	Opt.	Opt.	Opt.	Opt.
		MT 3	Opt.	Opt.	Opt.	Opt.
		MT 4	Opt.	Opt.	Opt.	Opt.
		ER Collet		1 Set	1 Set	1 Set
	Adapter Set		Opt.	Opt.	Opt.	Opt.

SPECIFICATIONS

Tooling Travel Range

unit : mm(in)

HD2200Y

O.D. Tool holder

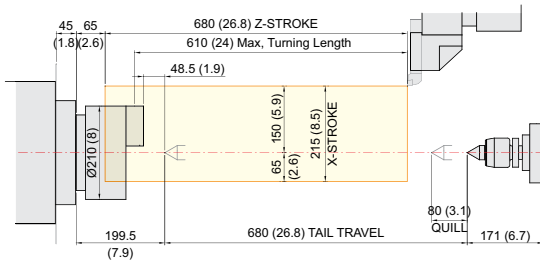

I.D. Tool holder

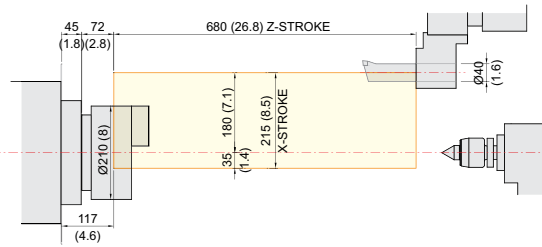

Straight Mill Holder

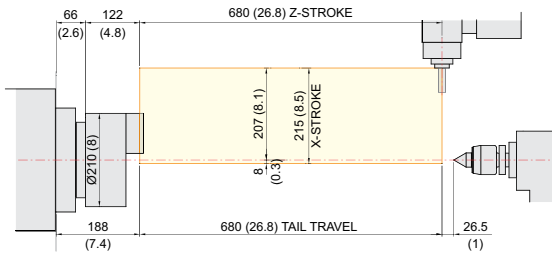

Angular Mill Holder

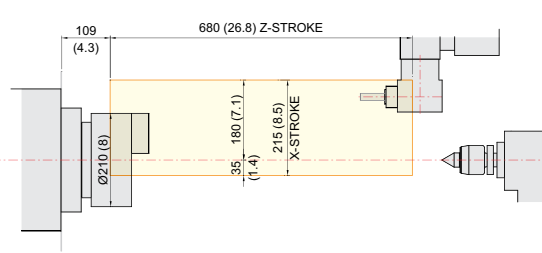

Face Tool holder

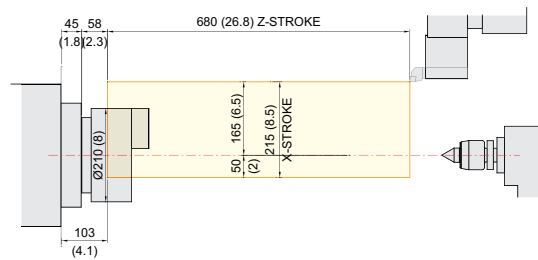

SPECIFICATIONS

Tooling Travel Range

unit : mm(in)

HD2200SY

O.D. Tool holder

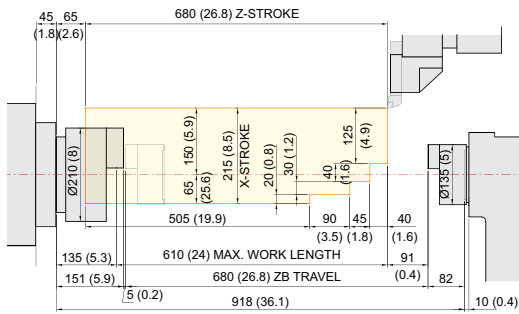

I.D. Tool holder

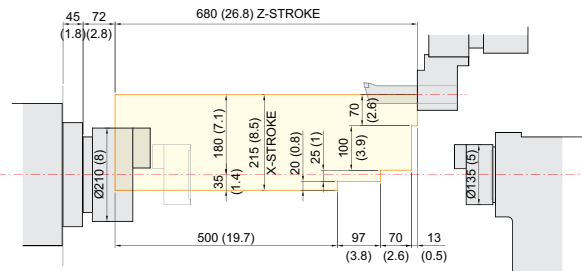

Straight Mill Holder

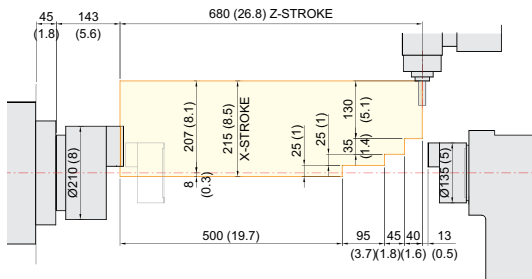

Angular Mill Holder

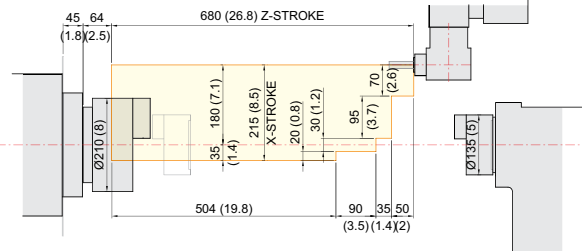

Face Tool holder

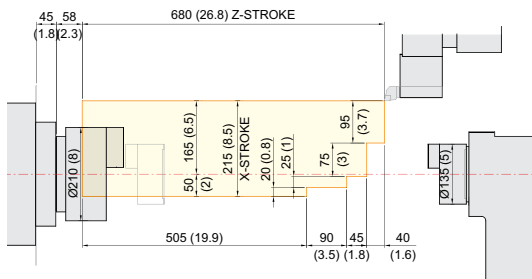

Sub Sp. Angular Mill Holder

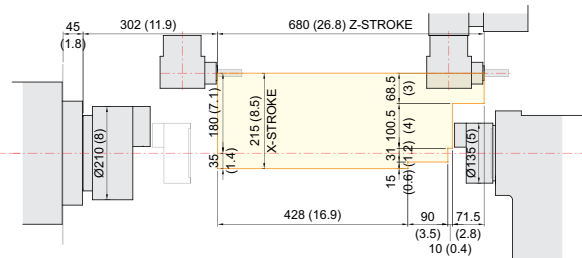

SPECIFICATIONS

Tooling Travel Range

unit : mm(in)

HD2600Y

O.D. Tool holder

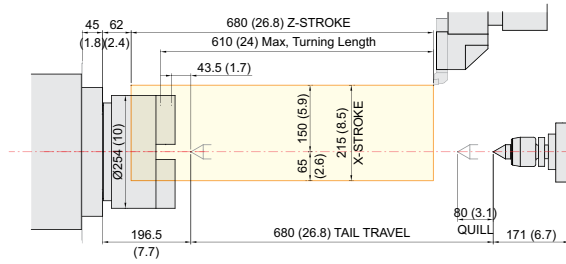

I.D. Tool holder

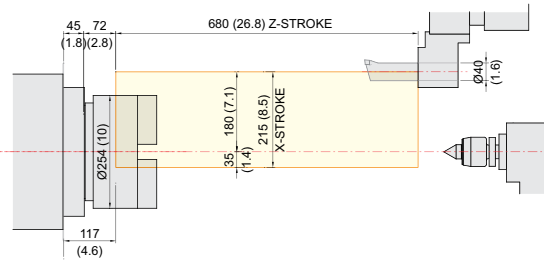

Straight Mill Holder

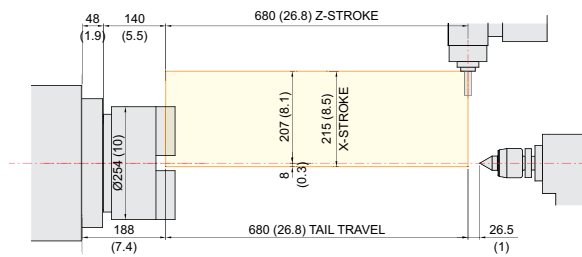

Angular Mill Holder

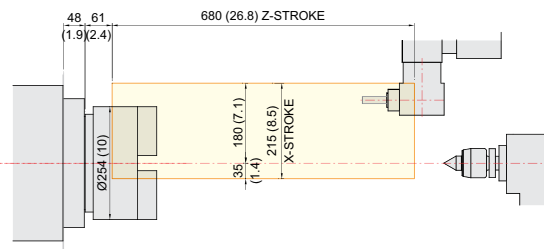

Face Tool holder

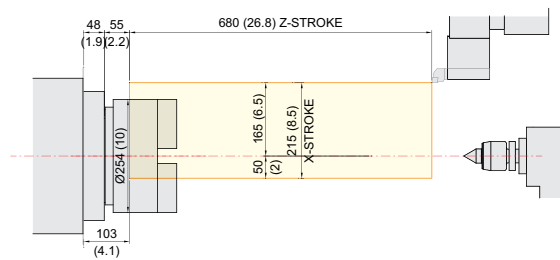

SPECIFICATIONS

Tooling Travel Range

unit : mm(in)

HD2600SY

O.D. Tool holder

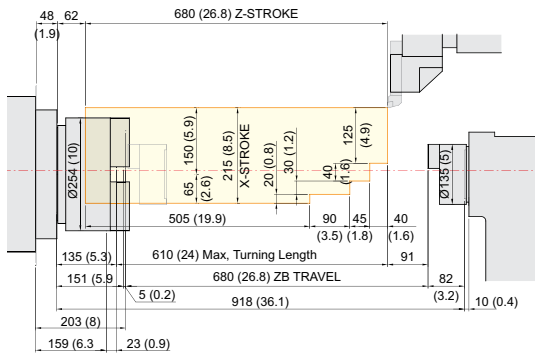

I.D. Tool holder

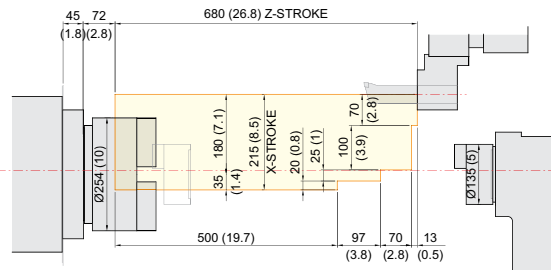

Straight Mill Holder

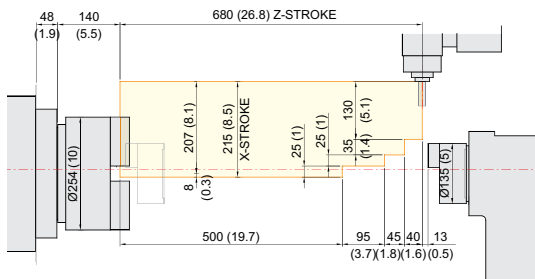

Angular Mill Holder

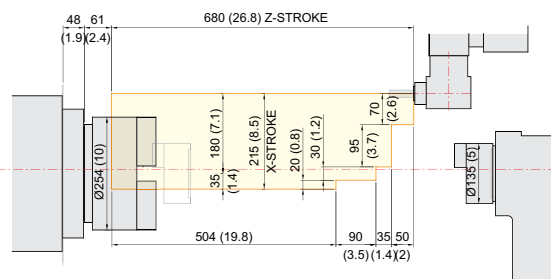

Face Tool holder

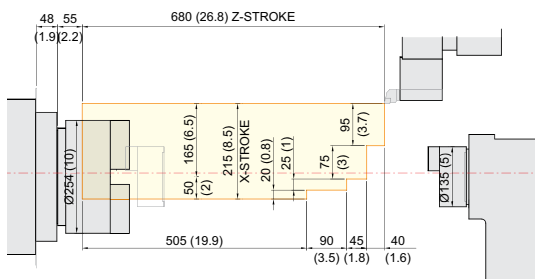

Sub Sp. Angular Mill Holder

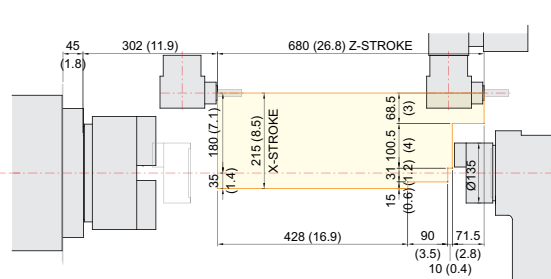

SPECIFICATIONS

Tooling Travel Range

unit : mm(in)

HD3100YA

O.D. Tool holder

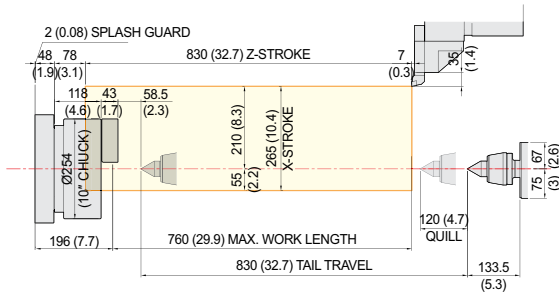

I.D. Tool holder

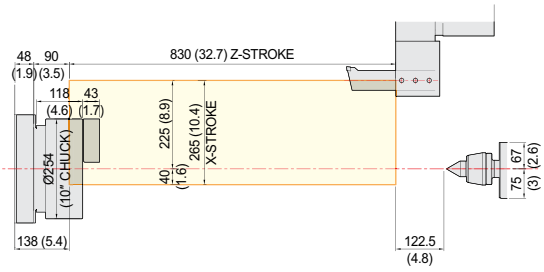

Axial driven Tool holder

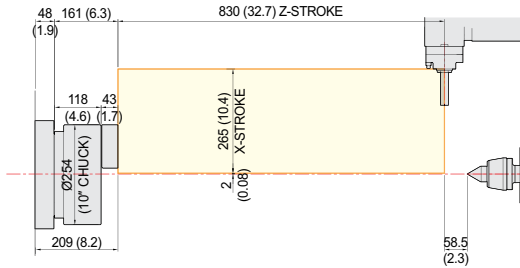

Angular driven Tool holder

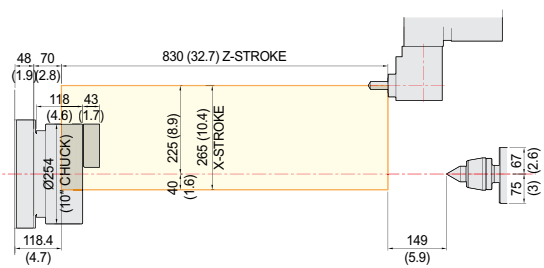

Face Tool holder

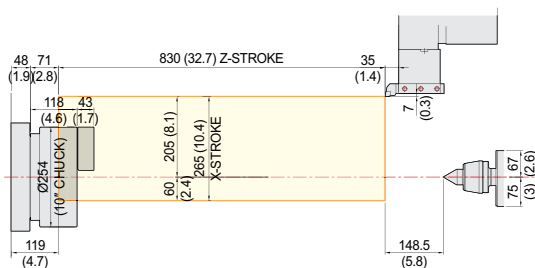

SPECIFICATIONS

Tooling Travel Range

unit : mm(in)

HD3100SYA

O.D. Tool holder

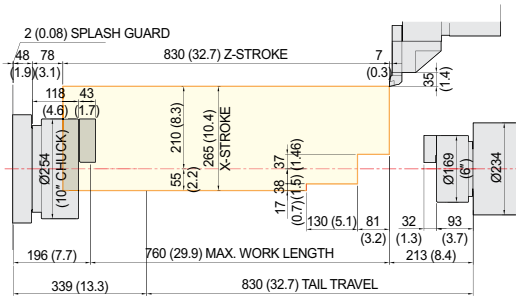

I.D. Tool holder

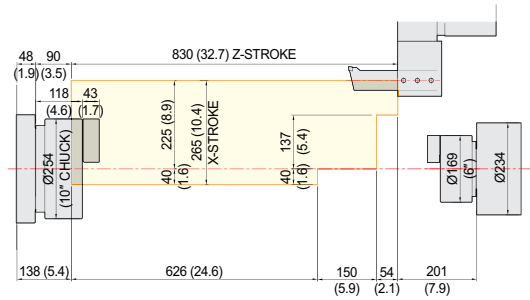

Axial driven Tool holder

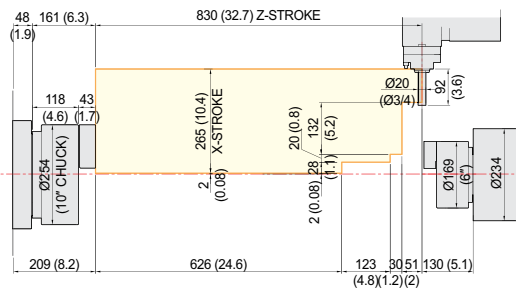

Angular driven Tool holder

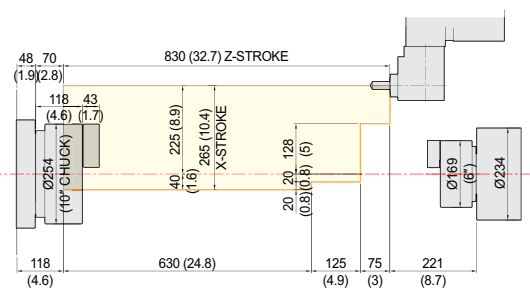

Face Tool holder

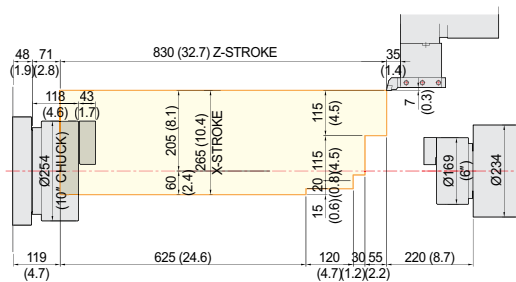

SPECIFICATIONS

Tooling Travel Range

unit : mm(in)

HD3100Y

O.D. Tool holder

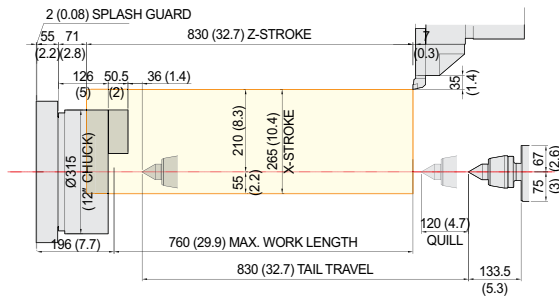

I.D. Tool holder

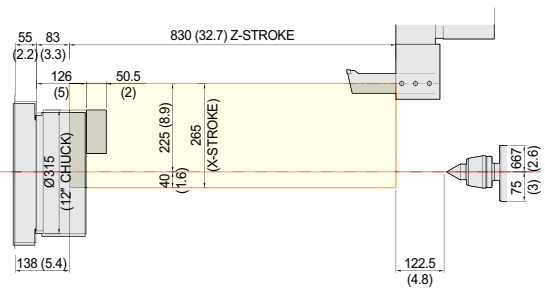

Axial driven Tool holder

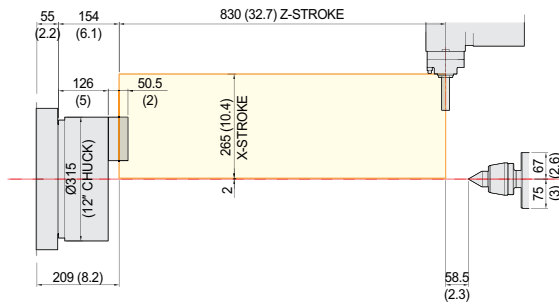

Angular driven Tool holder

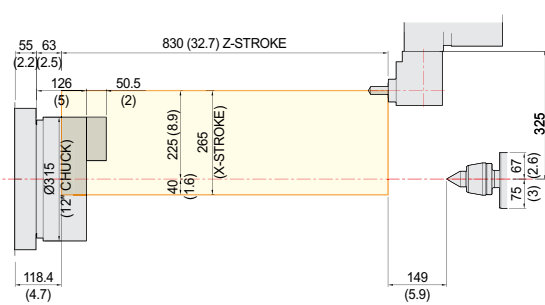

Face Tool holder

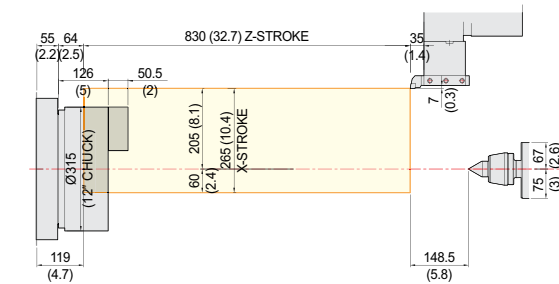

SPECIFICATIONS

Tooling Travel Range

unit : mm(in)

HD3100SY

O.D. Tool holder

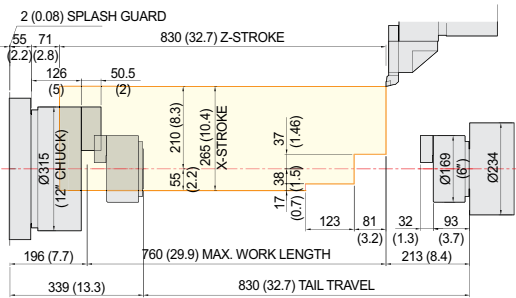

I.D. Tool holder

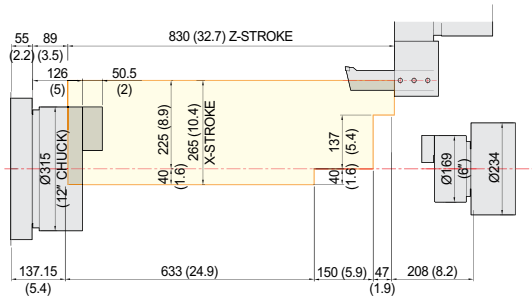

Axial driven Tool holder

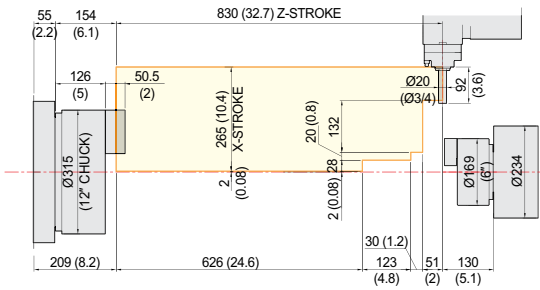

Angular driven Tool holder

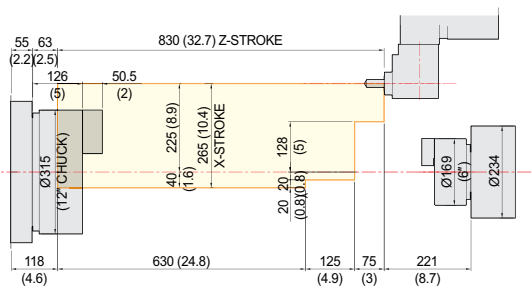

Face Tool holder

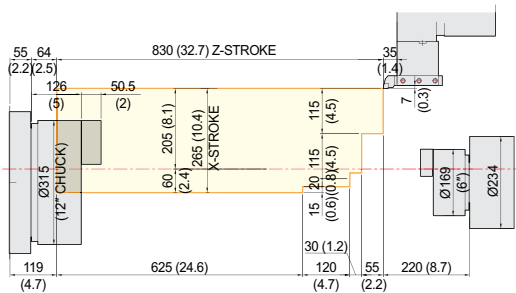

SPECIFICATIONS

Tooling Travel Range

unit : mm

HD3100LY

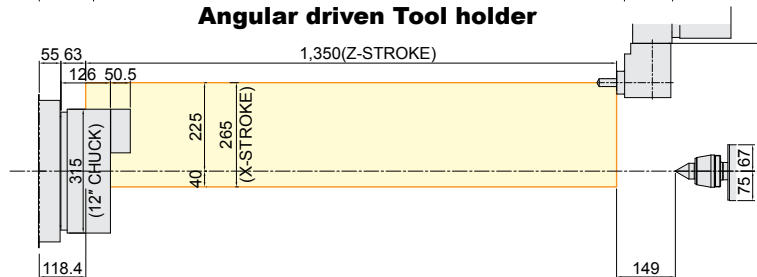
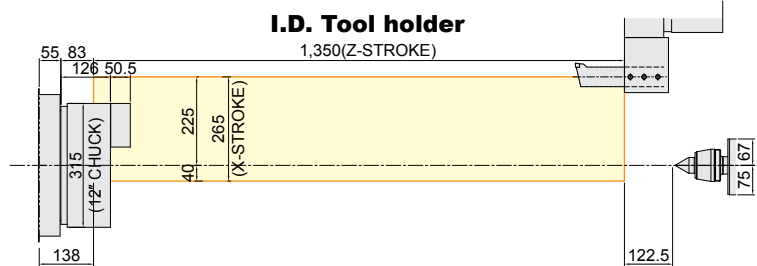
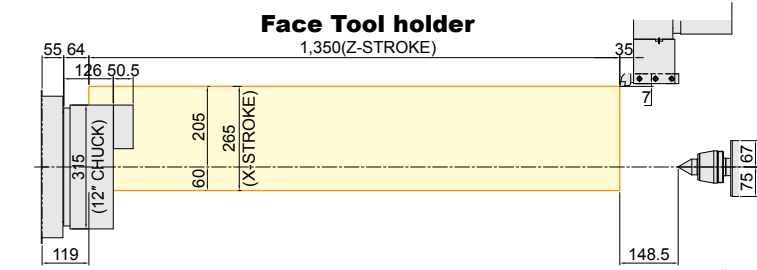
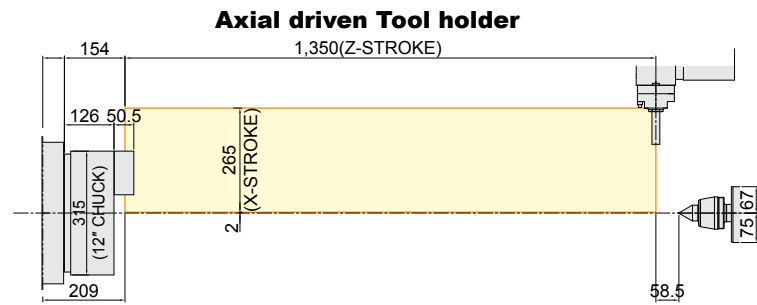
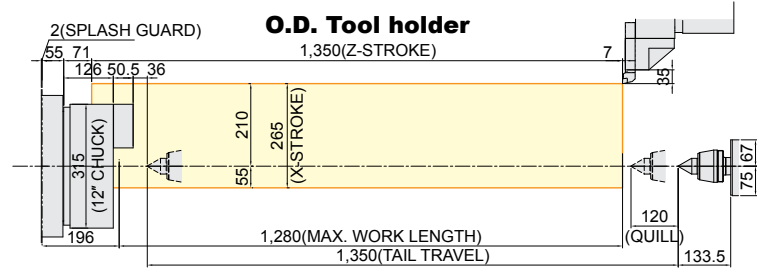

SPECIFICATIONS

Tooling Travel Range

unit : mm

HD3100LYA

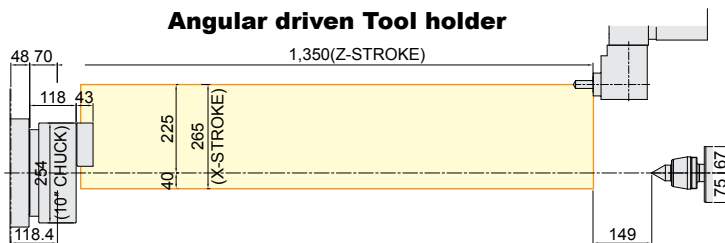
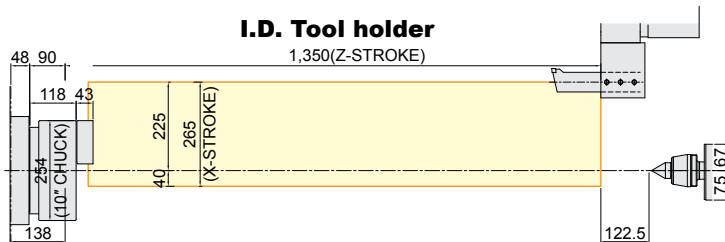
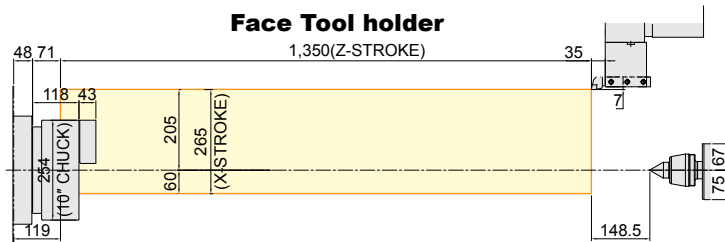
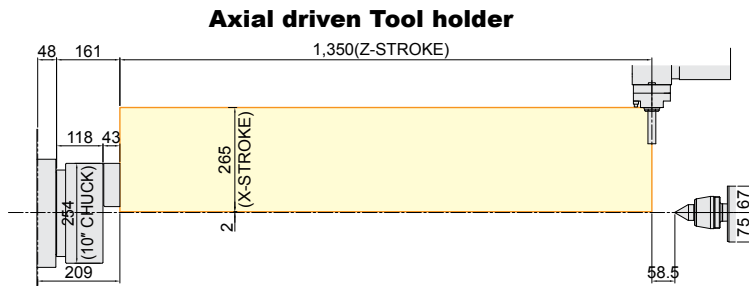
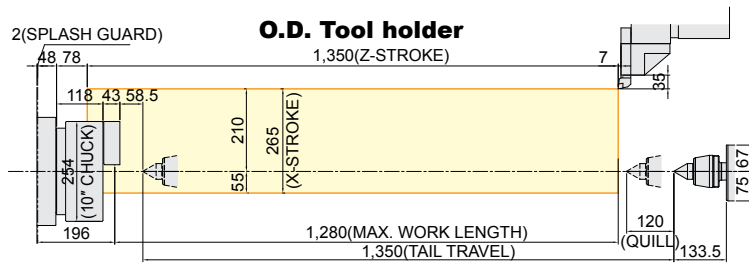

*) Using 50Hz voltage instead of 60Hz may lower the output of motors. (excluding servo motors and inverter motors)
Specifications are subject to change without notice for improvement.

SPECIFICATIONS

Specifications

[] : Option

ITEM			HD2200Y	HD2200SY
CAPACITY	Swing Over the Bed	mm(in)	Ø820 (Ø32.3")	
	Swing Over the Carriage	mm(in)	Ø650 (Ø25.6")	
	Max. Turning Dia.	mm(in)	Ø300 (Ø11.8")	
	Max. Turning Length	mm(in)	610 (24")	
	Bar Capacity	Main	mm(in)	Ø65 (Ø2.6")
Sub		mm(in)	-	Ø32 (Ø1.3")
SPINDLE	Chuck Size	Main	8"	
		Sub	5"	
	Spindle Bore	Main	Ø76 (Ø3")	
		Sub	Ø43 (Ø1.7")	
	Spindle Speed (rpm)	Main	4,000 [4,000] [4,000]	
		Sub	6,000 [6,000]	
	Motor (Max/Cont.)	Main	18.5/15 (25/20) [18.5/15 (25/20)] [22.5/15 (30/20)]	
		Sub	5.5/3.7 (7.4/5) [7.4/4.9 (9.9/6.6)]	
	Torque (Max/Cont.)	Main	206.2/125.4 [353.5/215] [215/143.3]	
		Sub	46.6/23.5 [47/31.1]	
	Spindle Type	Main	BELT	
Sub		BELT		
Spindle Nose	Main	A2-6		
	Sub	mm(in)	FLAT Ø110 (4.3")	
C-axis Indexing	deg	0.001°		
FEED	Travel	X/Y	215/110 {±55} (8.5"/4.3" {±2.17"})	
		Z/ZB	680 (26.8")	680/680 (26.8"/26.8")
	Rapid Traverse Rate	X/Y	24/10 (944/394)	
		Z/ZB	30 (1,181)	30/24 (1,181/994)
Slide Type	-	BOX GUIDE		
TURRET	No. of Tools	ea	12 [24]	
	Tool Size	O.D	□ 25 (□ 1") [24 Tool : □ 20 (□ 3/4")]	
		I.D	Ø40 (Ø1.6") [24T : SINGLE Ø40 (Ø1.6"), DOUBLE Ø20 (Ø0.8"), TRIPLE Ø20 (Ø0.8")]	
	Indexing Time	sec/step	0.2	
Y-Axis Type	-	WEDGE TYPE		
LIVE TOOL	Milling Tool Speed (rpm)	r/min	6,000 [6,000]	
	Motor (Max/Cont.)	kW(HP)	5.5/3.7 (7.4/5) [4.2/2.8 (5.6/4)]	
	Torque (Max/Cont.)	N-m	52.5/26.5 [40.1/26.8]	
	Collet Size	mm(in)	Ø16 (Ø5/8") {ER25}	
	Type	-	BMT55	
TAIL STOCK	Taper	-	MT#4	
	Quill Dia.	mm(in)	Ø80 (Ø3.1")	
	Quill Travel	mm(in)	120 (4.7")	
	Travel	mm(in)	680 (26.8")	
TANK CAPACITY	Coolant Tank	ℓ (gal)	200 (52.8)	
	Lubricating Tank	ℓ (gal)	2 (0.5)	
POWER SUPPLY	Electric Power Supply	kVA	27	32
	Thickness of Power Cable	mm²	Over 25	
	Voltage	V/Hz	220/60 (200/50*)	
MACHINE	Floor Space (L×W)	mm(in)	3,380×1,800 (133.1"×70.9")	
	Height	mm(in)	1,950 (76.8")	
	Weight	kg(lb)	4,700 (10,362)	4,900 (10,803)
CNC	Controller	-	HYUNDAI WIA FANUC i Series - Smart Plus [SIEMENS 828D]	

*) Using 50Hz voltage instead of 60Hz may lower the output of motors. (excluding servo motors and inverter motors)
Specifications are subject to change without notice for improvement.

SPECIFICATIONS

Specifications

[] : Option

ITEM			HD2600Y	HD2600SY	
CAPACITY	Swing Over the Bed	mm(in)	Ø820 (Ø32.3")		
	Swing Over the Carriage	mm(in)	Ø650 (Ø25.6")		
	Max. Turning Dia.	mm(in)	Ø300 (Ø11.8")		
	Max. Turning Length	mm(in)	610 (24")		
	Bar Capacity	Main	mm(in)	Ø81 (Ø3.2")	
Sub		mm(in)	-	Ø32 (Ø1.3")	
SPINDLE	Chuck Size	Main	inch	10"	
		Sub	inch	-	5"
	Spindle Bore	Main	mm(in)	Ø91 (Ø3.6")	
		Sub	mm(in)	-	Ø43 (Ø1.7")
	Spindle Speed (rpm)	Main	r/min	3,500 [3,500]	
		Sub	r/min	-	6,000 [6,000]
	Motor (Max/Cont.)	Main	kw(HP)	18.5/15 (25/20) [32.3 /17 (43.3/22.8)]	
		Sub	kw(HP)	-	5.5/3.7 (7.4/5) [7.4/4.9 (9.9/6.6)]
	Torque (Max/Cont.)	Main	N·m	400.7/243.7 [524.7/276.1]	
		Sub	N·m	-	46.6/23.5 [47/31.1]
Spindle Type	Main	-	BELT		
	Sub	-	-	BELT	
Spindle Nose	Main	-	A2-8		
	Sub	mm(in)	-	FLAT Ø110 (4.3")	
C-axis Indexing	deg	0.001°			
FEED	Travel	X/Y	mm(in)	215/110 {±55} (8.5"/4.3" {±2.17"})	
		Z/ZB	mm(in)	680 (26.8")	680/680 (26.8"/26.8")
	Rapid Traverse Rate	X/Y	m/min(ipm)	24/10 (944/394)	
		Z/ZB	m/min(ipm)	30 (1,181)	30/24 (1,181/994)
Slide Type	-	BOX GUIDE			
TURRET	No. of Tools	ea	12 [24]		
	Tool Size	O.D	mm(in)	□25 (□1") [24 Tool : □20 (□3/4")]	
		I.D	mm(in)	Ø40 (Ø1.6") [24T : SINGLE Ø40 (Ø1.6"), DOUBLE Ø20 (Ø0.8"), TRIPLE Ø20 (Ø0.8")]	
	Indexing Time	sec/step	0.2		
Y-Axis Type	-	WEDGE TYPE			
LIVE TOOL	Milling Tool Speed (rpm)	r/min	6,000 [6,000]		
	Motor (Max/Cont.)	kw(HP)	5.5/3.7 (7.4/5) [4.2/2.8 (5.6/4)]		
	Torque (Max/Cont.)	N·m	52.5/26.5 [40.1/26.8]		
	Collet Size	mm(in)	Ø16 (Ø5/8") {ER25}		
	Type	-	BMT55		
TAIL STOCK	Taper	-	MT#4		
	Quill Dia.	mm(in)	Ø80 (Ø3.1")		
	Quill Travel	mm(in)	120 (4.7")		
	Travel	mm(in)	680 (26.8")		
TANK CAPACITY	Coolant Tank	ℓ (gal)	200 (52.8)		
	Lubricating Tank	ℓ (gal)	2 (0.5)		
POWER SUPPLY	Electric Power Supply	kVA	27 [32]	32 [36]	
	Thickness of Power Cable	mm ²	Over 25		
	Voltage	V/Hz	220/60 (200/50*)		
MACHINE	Floor Space (L×W)	mm(in)	3,380×1,800 (133.1"×70.9")		
	Height	mm(in)	1,950 (76.8")		
	Weight	kg(lb)	4,800 (10,582)	5,000 (11,023)	
CNC	Controller	-	HYUNDAI WIA FANUC i Series - Smart Plus [SIEMENS 828D]		

*) Using 50Hz voltage instead of 60Hz may lower the output of motors. (excluding servo motors and inverter motors)

Specifications are subject to change without notice for improvement.

SPECIFICATIONS

Specifications

[] : Option

ITEM			HD3100YA	HD3100SYA	HD3100Y	HD3100SY
CAPACITY	Swing Over the Bed	mm(in)	Ø800 (Ø31.5")			
	Swing Over the Carriage	mm(in)	Ø670 (Ø26.4")			
	Max. Turning Dia.	mm(in)	Ø420 (Ø16.5")			
	Max. Turning Length	mm(in)	760 (Ø29.9")			
	Bar Capacity	Main	mm(in)	Ø81 (Ø3.2")		Ø102 (Ø4")
Sub		mm(in)	-	Ø51 (Ø2")	-	Ø51 (Ø2")
SPINDLE	Chuck Size	Main	10"		12"	
		Sub	-	6"	-	6"
	Spindle Bore	Main	Ø91 (Ø3.6")		Ø115 (Ø4.5")	
		Sub	-	Ø62 (Ø2.4")	-	Ø62 (Ø2.4")
	Spindle Speed (rpm)	Main	3,500		2,800	
		Sub	-	4,500	-	4,500
	Motor (Max/Cont.)	Main	26/18.5 (35/25)		26/18.5 (35/25)	
		Sub	-	7.5/5.5 (10/7.4)	-	7.5/5.5 (10/7.4)
	Torque (Max/Cont.)	Main	734/522		1,051/672	
		Sub	-	85/47	-	85/47
	Spindle Type	Main	BELT			
		Sub	-	BELT	-	BELT
	Spindle Nose	Main	A2-8		A2-11	
		Sub	mm(in)	-	A2-5	-
C-axis Indexing	deg	0.001°				
FEED	Travel	X/Y	265/120 {±60} (10.4"/4.7" {±2.4"})			
		Z/ZB	830 (32.7")	830/830 (32.7"/32.7")	830 (32.7")	830/830 (32.7"/32.7")
	Rapid Traverse Rate	X/Y	24/10 (944/394)			
		Z/ZB	30 (1,181)	30/30 (1,181/1,181)	30 (1,181)	30/30 (1,181/1,181)
Slide Type	-	BOX GUIDE				
TURRET	No. of Tools	ea	12			
	Tool Size	O.D	□ 25 (□ 1")			
		I.D	Ø50 (Ø2")			
	Indexing Time	sec/step	0.2			
Y-Axis Type	-	WEDGE TYPE				
LIVE TOOL	Milling Tool Speed (rpm)	r/min	5,000			
	Motor (Max/Cont.)	kW(HP)	5.5/3.7 (7.4/5)			
	Torque (Max/Cont.)	N·m	70/35.4			
	Collet Size	mm(in)	Ø25 (Ø1") {ER32}			
	Type	-	BMT65P			
TAIL STOCK	Taper	-	MT#5	-	MT#5	-
	Quill Dia.	mm(in)	Ø100 (Ø3.9")	-	Ø100 (Ø3.9")	-
	Quill Travel	mm(in)	120 (4.7")	-	120 (4.7")	-
	Travel	mm(in)	830 (32.7")	-	830 (32.7")	-
TANK CAPACITY	Coolant Tank	ℓ (gal)	200 (52.8)			
	Lubricating Tank	ℓ (gal)	1.8			
POWER SUPPLY	Electric Power Supply	kVA	30	39	30	39
	Thickness of Power Cable	mm²	Over 25			
	Voltage	V/Hz	220/60 (200/50*)			
MACHINE	Floor Space (L×W)	mm(in)	3,630×1,910 (142.9"×75.2")			
	Height	mm(in)	1,960 (77.2")			
	Weight	kg(lb)	6,200 (13,669)		6,300 (13,889)	
CNC	Controller	-	HYUNDAI WIA FANUC i Series - Smart Plus			

*) Using 50Hz voltage instead of 60Hz may lower the output of motors. (excluding servo motors and inverter motors)
Specifications are subject to change without notice for improvement.

SPECIFICATIONS

Specifications

[] : 선택사양

ITEM			HD2600Y	HD2600SY
CAPACITY	Swing Over the Bed	mm(in)	Ø800 (Ø31.5")	
	Swing Over the Carriage	mm(in)	Ø670 (Ø26.4")	
	Max. Turning Dia.	mm(in)	Ø420 (Ø16.5")	
	Max. Turning Length	mm(in)	1,280 (50.43")	
	Bar Capacity	mm(in)	Ø81 (Ø31.9")	Ø102 (Ø40.1")
SPINDLE	Chuck Size	inch	10"	12"
	Spindle Bore	mm(in)	Ø91 (Ø35.8")	Ø115 (Ø45.3")
	Spindle Speed (rpm)	r/min	3,500	2,800
	Motor (Max/Cont.)	kW(HP)	26(34.8)/18.5(24.8)	
	Torque (Max/Cont.)	N·m	734/522	1,051/672
	Spindle Type	-	BELT	
	Spindle Pose	-	A2-8	A2-11
	C-axis Indexing	deg	0.001°	
FEED	Travel	X/Y/Z m/min(ipm)	265/120(±60)/1,350 (10.4"/4.7" {±2.36"})	
	Rapid Traverse Rate	X/Y/Z m/min(ipm)	24/10/30 (944/394/1,181)	
	Slide Type	-	BOX GUIDE	
TURRET	No. of Tools	ea	12	
	Tool Size	O.D	mm(in)	□ 25 (9.8")
		I.D	mm(in)	Ø50 (Ø19.7")
	Indexing Time	sec/step	0.2	
	Y-Axis Type	-	WEDGE TYPE	
LIVE TOOL	Milling Tool Speed (rpm)	r/min	5,000	
	Motor (Max/Cont.)	kW(HP)	5.5/3.7 (7.4/5)	
	Torque (Max/Cont.)	N·m	70/35.4	
	Collet Size	mm(in)	Ø25 (Ø9.8") (ER32)	
	Type	-	BMT65	
TAIL STOCK	Taper	-	MT#5 [Built-in : MT#4]	
	Quill Dia.	mm(in)	Ø100 (Ø39.4")	
	Quill Travel	mm(in)	120 (47.2")	
	Travel	mm(in)	1,350 (Ø53.1")	
TANK CAPACITY	Coolant Tank	ℓ (gal)	220 (58.1)	
	Lubricating Tank	ℓ (gal)	1.8 (0.47)	
POWER SUPPLY	Electric Power Supply	kVA	30	
	Thickness of Power Cable	mm ²	Over 25	
	Voltage	V/Hz	220/60 (200/50)	
MACHINE	Floor Space (L×W)	mm(in)	4,404(173.4")×2,085 (82.1")	
	Height	mm(in)	2,022 (79.6")	
	Weight	kg(lb)	7,350 (16,203)	7,400 (16,314)
CNC	Controller	-	H/W FANUC i Series - Smart Plus	

CONTROLLER

HYUNDAI WIA FANUC i Series – Smart Plus

[] : Option

Controlled axis / Display / Accuracy Compensation	
Control axis	2 axis (X, Z) / 3 axis (X, Z, C) / 4 axis (X,Z,Y,C) 5 axis (X, Z, B, C, A) / 6 axis (X, Z, Y, B, C, A) 7 axis (X1/Z1, X2/Z2, B2, C1/C2)
Simultaneously controlled axis	2 axis [Max. 4 axis]
Designation of spindle axis	3 axis [Max. 4 axis]
Least setting Unit	X, Z, Y, B axis : 0.001 mm (0.0001 inch) C, A axis : 0.001 deg
Least input increment	X, Z, Y, B axis : 0.001 mm (0.0001 inch) C, A axis : 0.001 deg
Inch / Metric conversion	G20 / G21
High response vector control	
Interlock	All axis / Each axis
Machine lock	All axis
Backlash compensation	± 0~9999 pulses (exc.Rapid traverse / Cutting feed)
Position switch	
LCD / MDI	15 inch LCD unit (with Touch Panel)
Feedback	Absolute motor feedback
Stored stroke check 1	Over travel
Stored stroke check 2, 3	
PMC axis control	
Operation	
Automatic operation (Memory)	
MDI operation	
DNC operation	Needed DNC software / CF card
Program restart	
Wrong operation prevention	
Program check function	Dry run
Single block	
Search function	Program Number / Sequence Number
Interpolation functions	
Nano interpolation	
Positioning	G00
Linear interpolation	G01
Circular interpolation	G02, G03
Exact stop mode	Single : G09, Continuous : G61
Dwell	G04, 0 ~ 9999.9999 sec
Skip	G31
Reference position return	1st reference : G28, 2nd reference : G30 Ref. position check : G27
Thread synchronous cutting	G33
Thread cutting retract	
Variable lead thread cutting	
Multi / Continuous threading	
Feed function / Acc. & Dec. control	
Manual feed	Rapid traverse Jog : 0~2,000 mm/min (79 ipm) Manual handle : x1, x10, x100 pulses Reference position return
Cutting Feed command	Direct input F code
Feedrate override	0 ~ 200% (10% Unit)
Rapid traverse override	1%, F25%, 50%, 100%
Override cancel	
Feed per minute	G98
Feed per revolution	G99
Look-ahead block	1 block
Program input	
Tape Code	EIA / ISO
Optional block skip	9 ea
Program stop / end	M00, M01 / M02, M30
Maximum command unit	± 999,999.999 mm (± 99,999.9999 inch)
Plane selection	X-Y : G17 / Z-X : G18 / Y-Z : G19
Workpiece coordinate system	G52, G53, 6 pairs (G54 ~ G59)
Manual absolute	Fixed ON
Programmable data input	G10
Sub program call	10 folds nested
Custom macro	#100 ~ #199, #500 ~ #999
G code system	A, B/C
Programmable mirror image	G51.1, G50.1
G code preventing buffering	G4.1
Direct drawing dimension program	Including Chamfering / Corner R
Conversational Program	Smart Guide-i

Program input	
Multiple repetitive cycles	I, II
Canned cycle for turning	
Auxiliary function / Spindle speed function	
Auxiliary function	M & 4 digit
Level-up M Code	High speed / Multi / Bypass M code
Spindle speed function	S & 5 digit , Binary output
Spindle override	0% ~ 150% (10% Unit)
Multi position spindle orientation	M19 (S##)
Rigid tapping	
Constant surface speed control	G96, G97
Tool function / Tool compensation	
Tool function	T & 2 digit + Offset 2 digit
Tool life management	
Tool offset pairs	128 pairs
Tool nose radius compensation	G40, G41, G42
Geometry / Wear compensation	
Direct input of offset measured B	
Editing function	
Part program storage size	5,120m (2MB)
No. of registerable programs	1,000 ea
Program protect	
Background editing	
Extended part program editing	Copy, move and change of NC program
Memory card program edit	
Data input / output & Interface	
I/O interface	CF card, USB memory Embedded Ethernet interface
Screen hard copy	
External message	
External key input	
External workpiece number search	
Automatic data backup	
Setting, display and diagnosis	
Self-diagnosis function	
History display & Operation	Alarm & Operator message & Operation
Run hour / Parts count display	
Maintenance information	
Actual cutting feedrate display	
Display of spindle speed / T code	
Graphic display	
Operating monitor screen	Spindle / Servo load etc.
Power consumption monitoring	Spindle & Servo
Spindle / Servo setting screen	
Multi language display	Support 24 languages
Display language switching	Selection of 5 optional Languages
LCD Screen Saver	Screen saver
Unexpected disturbance torque	BST (Back spin torque limit)
Function for machine type	
Cs contour control (C & A axis)	Mill, MS, Y, SY, LF-Mill, TTMS, TTSY
Polar coordinate interpolation	Mill, MS, Y, SY, LF-Mill, TTMS, TTSY
Cylindrical interpolation	Mill, MS, Y, SY, LF-Mill, TTMS, TTSY
Polygon turning (2 Spindles)	Mill, MS, Y, SY, LF-Mill, TTMS, TTSY
Canned cycle for drilling	Mill, MS, Y, SY, LF-Mill, TTMS, TTSY
Spindle orientation expansion	MS, SY, TTS, TTMS, TTSY
Spindle synchronous control	MS, SY, TTS, TTMS, TTSY
Torque control	MS, SY, TTS, TTMS, TTSY
Y axis offset	Y, SY, TTSY
Arbitrary angular control	Y, SY, TTSY
Composite / Superimposed control	MS, SY, TTS, TTMS, TTSY
Balance cutting	TTS, TTMS, TTSY
Option	
Fast ethernet	Needed option board
Data server	Needed option board
Protection of data at 8 levels	
Tool offset pairs	200 pairs
Helical interpolation	
Optional block skip	40 ea, 200 ea (AICC II)

CONTROLLER

SIEMENS 828D

[] : Option ☆ Needed technical consultation

Controlled axis / Display / Accuracy Compensation	
Control axis	2 axis (X, Z) – Std.
	3 axis (X, Z, C) – Mill
	4 axis (X, Z, Y, C) – Y
	5 axis (X, Z, B, C, A) – MS
	6 axis (X, Z, Y, B, C, A) – SY
	Max. 4 axis
Simultaneously controlled axis	Max. 4 axis
Least setting Unit	X, Z, Y, B axis : 0.001 mm (0.0001 inch)
	C, A axis : 1 deg [0.001] deg
Least input increment	X, Z, Y, B axis : 0.001 mm (0.0001 inch)
	C, A axis : 1 deg [0.001] deg
Inch / Metric changeover	G70 (inch) / G71 (metric)
Interlock	All axis / Each axis
Backlash compensation	
Pitch error compensation	Leadscrew pitch error compensation
LCD / MDI	10.4 inch color LCD [15 inch color LCD (With Touch panel)]
Keyboard	QWERTY full keyboard
Stored stroke check	Over travel
Operation	
Automatic operation	
MDI operation	
Program restart	
Program check function	Dry run / Program check / Machine lock
Single block	
Block search	Block search
Reposition	
Working area limit	Working area limitations
Interpolation functions	
Positioning	G00
Linear interpolation	G01
Circular interpolation	Circular interpolation CW (G02)
	Circular interpolation CCW (G03)
	Single block exact stop (G09)
Exact position stop	Exact stop G60 (G601, G602, G603)
Dwell	Dwell (G04)
Reference position return	Return to reference point
	Return to 2nd reference point
Helical interpolation	
Thread synchronous cutting	
Thread cutting retract	
Spline interpolation	Non-uniform rational B splines
Feed function / Acc. & Dec. control	
Manual feed	Rapid traverse
	Jog
	Manual handle
	Reference position return
Cutting feed command	Direct input F code
Feedrate override	0 ~ 200% (10% Unit)
Rapid traverse override	1%, 25%, 50%, 100%
Feed per minute	G94
Feed per revolution	G95
Look-ahead block	1 block
Program input	
ISO support	G291 (ISO) / G290 (SIEMENS)
	(ISO G Code system-A)
Optional block skip	2
Program stop / end	M00, M01 / M02, M30
Maximum command unit	± 999,999,999 mm, ± 99,999,9999 inch
Plane selection	X-Y : G17, X-Z : G18, Y-Z : G19
	G54 ~ G57, G505~G549
Workpiece coordinate system	G500 (Basic frame – settable zero offset)
	G53 (Work offset non modal)
	G153 (basic frame non modal)
Sub program call	11 folds nested
G code preventing buffering	STOPRE
Turning cycle	Turning programing (Cycle 93, 94, 95, 97)
User cycle	
3D simulation	
Real time simulation	
Shop Turn	Machining step programming for turning

Auxiliary function / Spindle speed function	
Auxiliary function	M Code 4 digit
Spindle speed function	S Code 5 digit
Spindle override	0% ~ 150% (10% Unit)
Spindle orientation	SPOS
Rigid tapping	
Automatic mode interchange	Spindle / Axis mode
Constant surface speed control	G96, G97
Spindle speed limitation	LIMS
Tool function / Tool compensation	
Tool function	Tool number & Tool name
	Tool : T + Offset : D
Tool life management	128 ea : Std.
	256 ea : Mill
	768 ea : Y, MS, SY
Cutting Edges in tool list	256 ea : Std.
	512 ea : Mill
Tool nose radius compensation	1,536 ea : Y, MS, SY
	ISO (G40, G41, G42)
Geometry / Wear compensation	
Measurement of tool length	
Tool management function	
Editing function	
Part program storage size	3MB – Std.
	5MB – Mill
	10MB – Y, MS, SY
No. of registerable programs	750 ea
External Storage devices	Local network, Server, USB, Flash drive
Background editing	
Extended part program editing	Copy, move and change of NC program
Memory card program edit	
Data input / output & Interface	
I/O interface	CF card interface (ONLY 10.4")
	USB memory interface
	Embedded Ethernet memory interface
Screenshot	
Setting, display and diagnosis	
Self-diagnosis function	
History display & Operation	Alarm & Operator message & Operation
Run hour / Parts count display	
Maintenance information	
Actual cutting feedrate display	
Display of spindle speed / T code	
Graphic display	
Operating monitor screen	Spindle / Servo load etc.
	Support 9 languages
Multi language display	Chinese (Simplified/Traditional), English, French, German, Italian, Korean, Portuguese, Spanish
	[☆ Support 22 languages : Inquiry need]
LCD Screen Saver	Screen saver & Motion sensing
Function for machine type	
Cs contour control (C & A axis)	Mill, MS, Y, SY model
Polar coordinate interpolation	Mill, MS, Y, SY model
Cylindrical interpolation	Mill, MS, Y, SY model
Canned cycle for drilling	Mill, MS, Y, SY model
[Polygon turning (CP-Basic)]	Mill, MS, Y, SY model
[Hobbing / Skybing (CP-Comfort)]	Mill, MS, Y, SY model
Spindle synchronous control	MS, SY model
Servo tailstock function	MS, SY model
Option	
Additional optional block skip	10
Contour handwheel	

Figures in inch are converted from metric values.

The FAULC controller specifications are subject to change based on the policy of company CNC supplying.

GLOBAL NETWORK

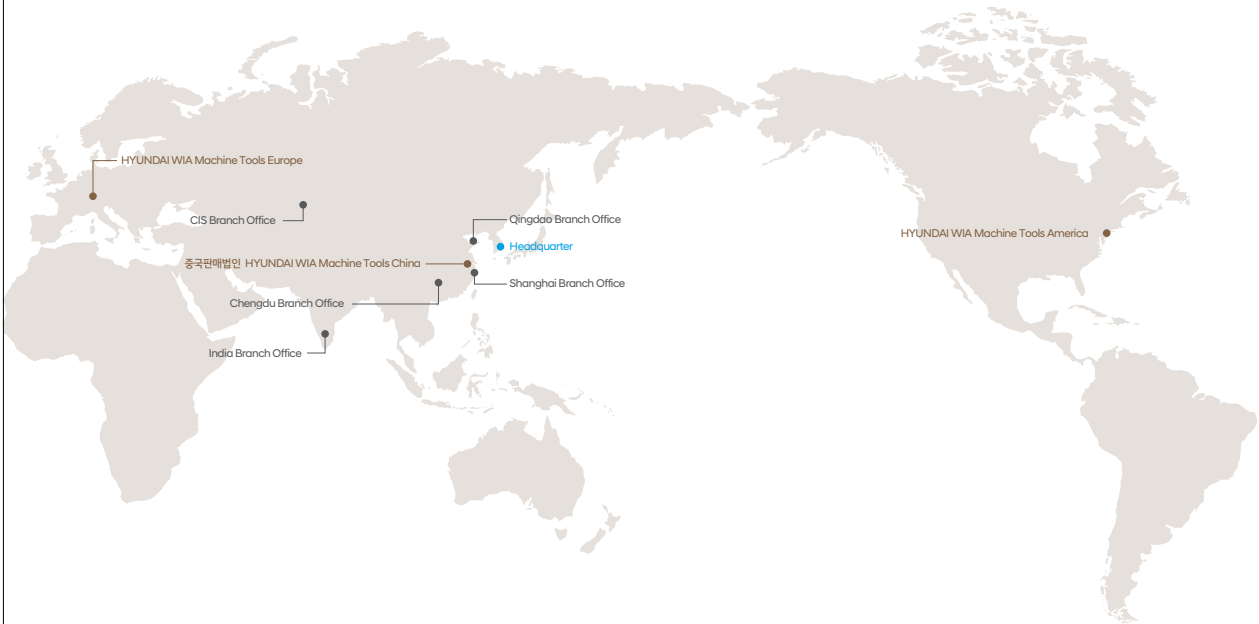

HEADQUARTER



R&D Center/Factory
153, Jeongdong-ro, Seongsan-gu,
Changwon-si, Gyeongsangnam-do, Korea
TEL : +82 55 280 9114



Overseas Sales Team /R&D Center
37, Cheoldobangmulgwan-ro, Uuiwang-si,
Gyeonggi-do, Korea
TEL : +82 31 8090 2539

EUROPE



HYUNDAI WIA Machine Tools Europe
Alexander-Fleming-Ring 57, DE-65428
Russelsheim am Main, Germany
TEL : +49-0-6142-9256-0

AMERICA



HYUNDAI WIA Machine Tools America
450 Commerce Blvd, Carlstadt, NJ 07072, USA
TEL : +1-201-987-7298

ASIA



HYUNDAI WIA Machine Tools China
Company No.16 Fenghuang Road, Fenghuang
Town, Zhangjiagang City, Jiangsu Province, China
TEL : +86-512-5637-9719



Shanghai Branch Office (China)
3F-04, MT1, MixC Park, No.229, HaowenRoad,
Minhang District, Shanghai, China
TEL : +86-21-6427-9885



Chengdu Branch Office (China)
Room 409B, Building 1, No.333, Yizhou Road,
High-Tech District, Chengdu, China
TEL : +86-21-5952-3256



Qingdao Branch Office (China)
Room 702, Yulong International Center, Building
1, No. 178-2, Haier Road, Laoshan District,
Qingdao, China. C.P. 266035
TEL : +86-28-8666-2985



CIS Branch Office
050051, Kazakhstan, Almaty, Elebekova street 10,
B.3, Office no.103
TEL : +7-(727)-355-7133



India Branch Office
#4/169, 1st Floor, LOTTE BLDG, Rajiv Gandhi
Salai, (OMR), Kandanchavadi, Chennai -600 096,
Tamilnadu, India
TEL : +91-76049-01618



You Tube HYUNDAI WIA MT
www.youtube.com/HYUNDAIWIAMT

CREATING VALUE IN SEAMLESS MOBILITY

With its top-quality HYUNDAI WIA machine tool creates a new and better world.



<http://machine.hyundai-wia.com>
HYUNDAI WIA Machine Tools
Global Links

HEADQUARTER

R&D Center/Factory 153, Jeongdong-ro, Seongsan-gu, Changwon-si, Gyeongsangnam-do, Korea TEL : +82 55 280 9114 FAX : +82 55 282 9114

Overseas Sales Team /R&D Center 37, Cheoldobangmulgwan-ro, Uiwang-si, Gyeonggi-do, Korea TEL : +82 31 8090 2539

OVERSEAS OFFICES

HYUNDAI WIA Machine America corp. 450 Commerce Blvd, Carlstadt, NJ 07072, USA TEL : +1-201-987-7298

HYUNDAI WIA Europe GmbH Alexander-Fleming-Ring 57, 65428 Rüsselsheim Germany TEL : +49-0-6142-9256-0

HYUNDAI WIA Machine Tools China Company No.16 Fenghuang Road, Fenghuang Town, Zhangjiagang City, Jiangsu Province, China TEL : +86-21-6427-9885

India Branch Office #4/169, 1st Floor, LOTTE BLDG, Rajiv Gandhi Salai, (OMR), Kandanchavadi, Chennai - 600096, Tamilnadu, India TEL : +91-76-0490-3348